

Control device (pH - Rx)

INSTALLATION MANUAL

EN

HANDBUCH

DE

MANUAL DE INSTALACION

ES

MANUEL D'INSTALLATION

FR

MANUALE D'INSTALLAZIONE

IT

РУКОВОДСТВО ПО УСТАНОВКЕ И ЭКСПЛУАТАЦИИ

RU

PACK CONTENTS

- A) pH and REDOX control device
- B) PVC Crystal 4x6 with suction device (2 m)
- C) Polyethylene delivery hose (3m)
- D) Attachment screw ($\phi=6$ mm)
- E) Foot filter (PVC riser)
- F) FPM duckbill valve (3/8" GAS)
- G) Probes pH and Redox
- H) PSS3 probe-socket (1/2" GAS)
- I) Tapping saddle for securing PSS3 onto 2" hose ($\phi=50$ mm)
- L) pH 4, pH 7, 465 mV, H₂O buffer solution kit
- M) Reducer for injection valve

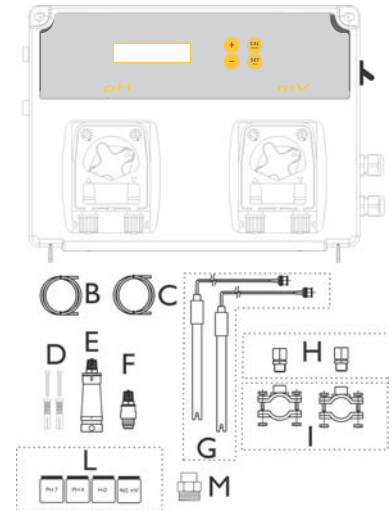

Wall Mounting Setup

TECHNICAL SPECIFICATIONS

Dimensions (H – W – L)	234x162x108 mm
Weight	1 kg
Power supply 50 Hz	230 VAC
Consumption	12 W or 18 W
Pump flow rate	1,5 l/h; 5 l/h
Maximum back-pressure	1,5 bar
Pump state	Pause - Supply
Measure scale	0 ÷ 14.0 pH; Redox 0 ÷ +1000 mV
pH control range	0.0 pH – 14.0 pH
Device precision	+/- 0,1 pH; ± 10 mV
Accuracy	±0.02 pH; ± 3 mV
Electrode regulation	Automatic

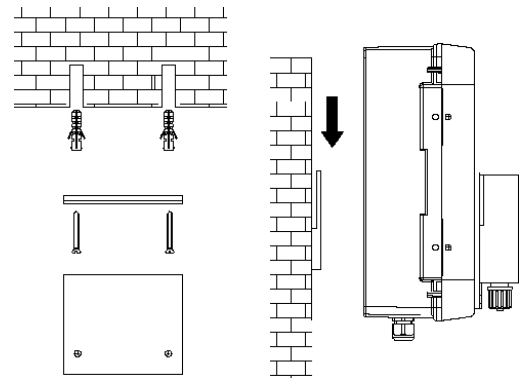

ATTENZIONE / WARNING / ATTENTION / ACHTUNG

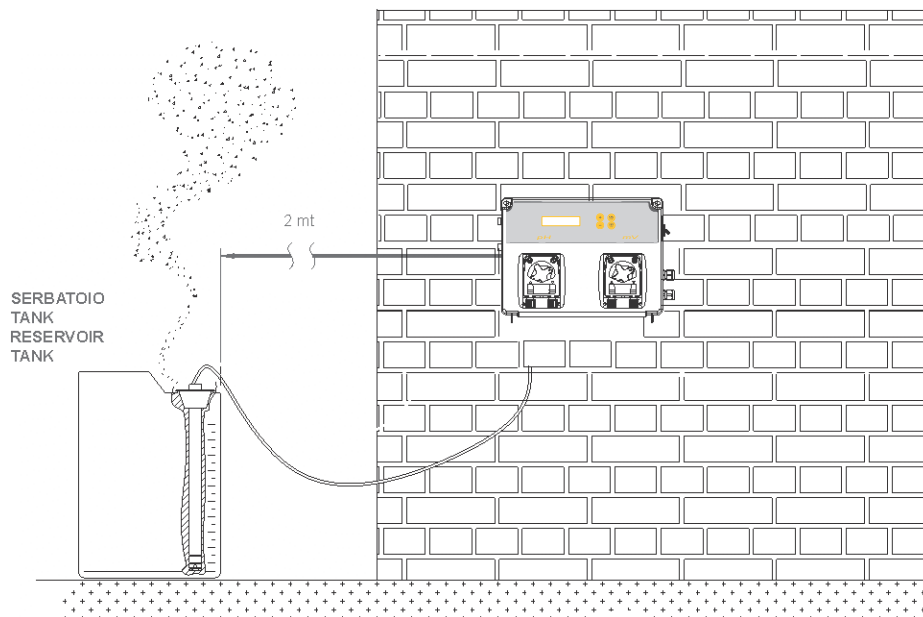

Instruction Setting

Functions:



- Calibration (Press Cal Key for 3 Seconds):
 - Select the calibration routine pH or Redox by Up or Down key.
 - Standard Routine calibration pH probe is 7 and 4 buffer solution and Redox 465 mV buffer solution



- Set Point (Press Set Key):
 - Press Set Key and choose SetPoint and adjust value with Up or Down Key before press Enter and confirm.

- **Sp_750mv__700_mv_**

- **Sp_7.4ph__7.6_ph_**



- Press Cal and Set Key (both) for 5 Seconds and run Program Setup:

- **Program_Menu** (Press Enter to set the following Item)

- **Language_** (It's possible to have 5 language EN, IT, SP, DE, FR)

- **Redox_Measure**

- **setpoint__750_mv** (Adjust value with enter and up or down key)
It's possible to adjust from 0 to 1000 mV value for Redox

- **sp_type__low** (Adjust value LOW or HIGH)

- **ofa_time_000_min** (Adjust value OFF or set Time)

- **alarm_band__000_rx** (Adjust value from 100 to 300 mV)

- **ph_Measure**

- **setpoint__7.4ph** (Adjust value with enter and up or down key)
It's possible to adjust from 0 to 14 pH value.

- **sp_type__acid** (Adjust value ACID or ALKA)

- **ofa_time_000_min** (Adjust value OFF or set Time)

- **alr_band__000_ph** (Adjust value from 1 pH to 3 pH)

- **Temp__25*C_**(Adjust value with enter and up or down key) pH measure only.

- **Flow_**(Adjust value with enter and up or down key Enable or Disable)
 - It's possible to enable(ON) or disable (OFF) signal input

- **Calibration_probe** (Adjust value with enter and up or down key)

- **Full** (pH 7 and 4, Redox 465 mV buffer solution)

- **Easy** (pH 7, Redox 465 mV buffer solution)

- **Off** (Disabled)

- **Password** (Adjust value with enter and up or down key, standard value **0000**)

- Save and escape Program setup with ESC key

- **Exit__save** (Adjust value with up or down key and confirm with enter key)



- Priming Pump Keep Press UP Key for 1 seconds and priming redox pump

- **priming__700mv**

- Priming Pump Keep Press Down Key for 1 seconds and priming pH pump

- **priming__7.2ph**

- Lock pump function

- Press Up and Enter (both) after 5 second flash **Rx_Stop** press again to unlock

- Press Down and Esc (both) after 5 second flash **pH_Stop** press again to unlock

- The unit doses in proportional mode respect at Set Point (minimum distance 25%, maximum distance 90% of 10 minutes time period dosing)

Note: The unit in program menu to go out in automatic mode after 1 minutes of wait time, the unit doesn't save nothing.



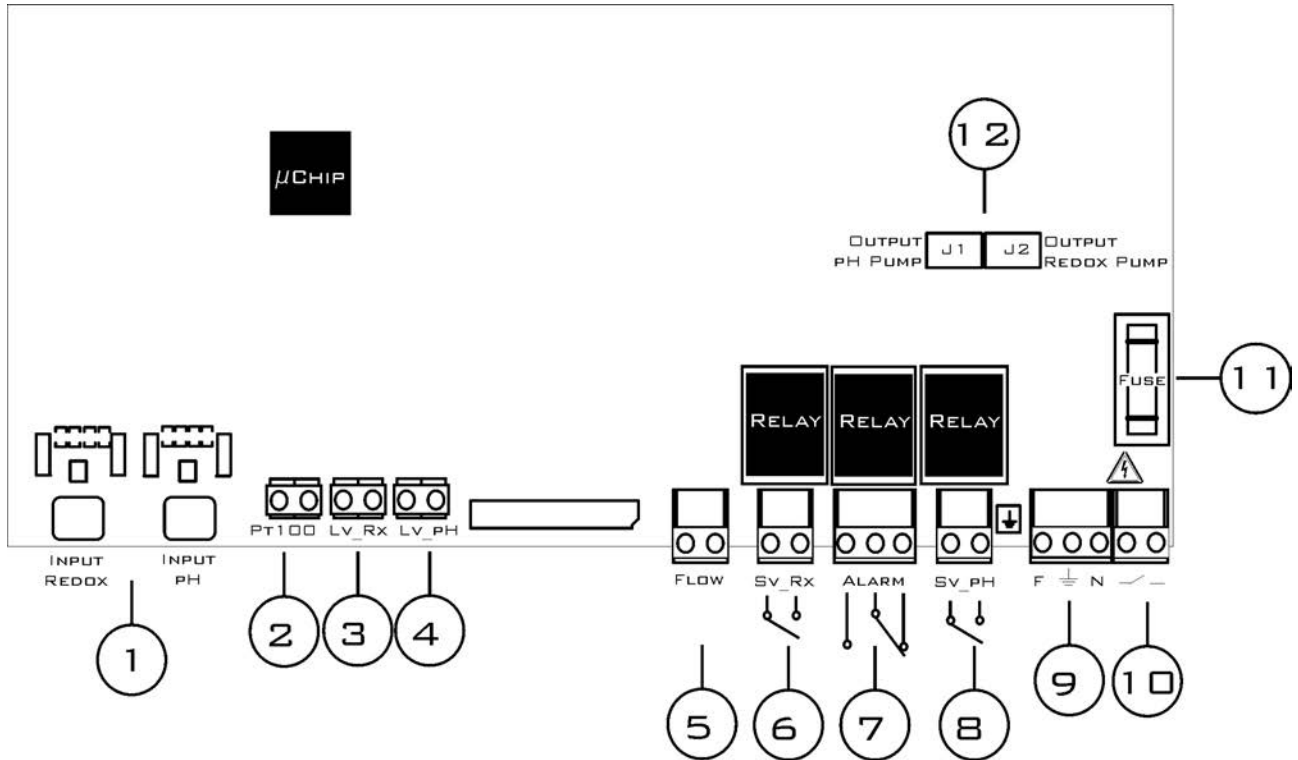







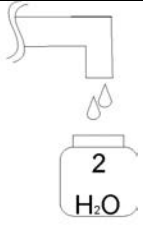

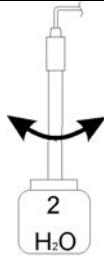
Main board

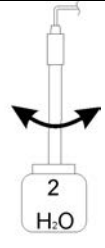

Wire Connection:

- 1) Input pH and Redox Probe
- 2) Input Temperature Probe (PT100)
- 3) Input Level Probe Redox (Product Tank)
- 4) Input Level Probe pH (Product Tank)
- 5) Input Flow Rate (High Voltage 230 Vac)
- 6) Output Relay Solenoid Valve Redox (Dry contact, Relay 250 Vac 10 A)
- 7) Output Relay Alarm remote (Dry contact, Relay 250 Vac 10 A)
- 8) Output Relay Solenoid Valve pH (Dry contact, Relay 250 Vac 10 A)
- 9) Power Supply 230 Vac
- 10) Switch Power Supply
- 11) Fuse 500 mA Delay
- 12) Output pH (J1) and Redox (J2) pumps







pH Probe Calibration

 <p>①</p>	 <p>②</p>	 <p>③</p> <p>Wash</p>
 <p>④</p> <p>Keep probe into Buffer solution</p>	<p>Calibration</p>  <p>Press Cal Key 3 Seconds Set pH calibration</p> <p>5</p>	<p>Press_cal</p>  <p>Calibration During 1 minutes</p> <p>Wait_____60s_</p> <p>6</p>
<p>7pH_Quality_100%</p> <p>Quality Probe</p> <p>7</p>	 <p>⑧</p> <p>Wash</p>	 <p>⑨</p> <p>Keep probe into Buffer solution</p>
<p>4pH__Press_cal</p>  <p>Calibration During 1 minutes</p> <p>Wait_____60s_</p> <p>10</p>	<p>4pH_Quality_100%</p> <p>Quality Probe</p> <p>11</p>	 <p>⑫</p> <p>Wash</p>
 <p>⑬</p>	 <p>Press Enter Key to save and exit</p> <p>14</p>	<p>15</p> <p>Normal Status</p>

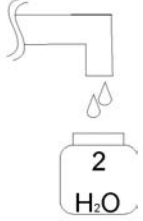
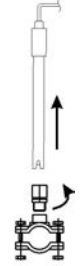
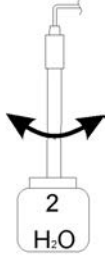
Note:

If you have setting Calibration = Easy the function has 1 point calibrate only 7 pH buffer solution.

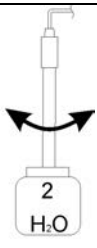
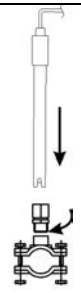
Redox Probe Calibration

 <p>1</p>	 <p>2</p>	 <p>3</p> <p>Wash</p>
 <p>4</p> <p>Keep probe into Buffer solution</p>	<p>5</p> <p>Calibration</p>  <p>Press Cal Key 3 Seconds Set Redox calibration</p>	<p>6</p> <p>465mv__Press_cal</p>  <p>Calibration During 1 minutes</p> <p>Wait_____60s__</p>
<p>7</p> <p>465mv_Quality_100%</p> <p>Quality Probe</p>	<p>8</p> 	<p>9</p> 
 <p>10</p> <p>Press Cal Key 3 Second</p>	<p>11</p> <p>Normal Status</p>	

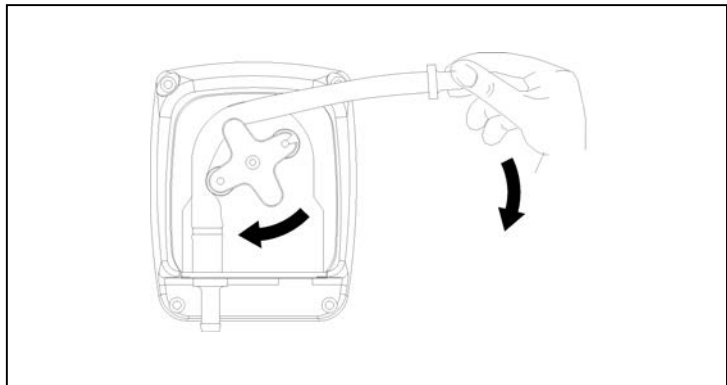
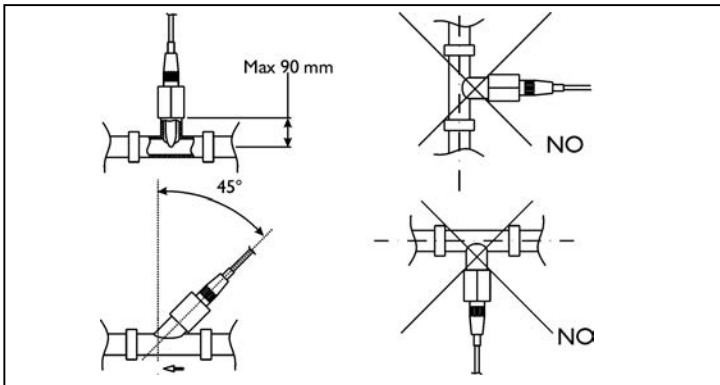
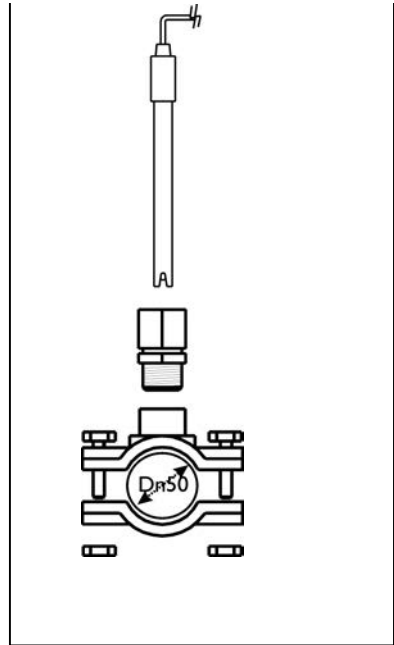
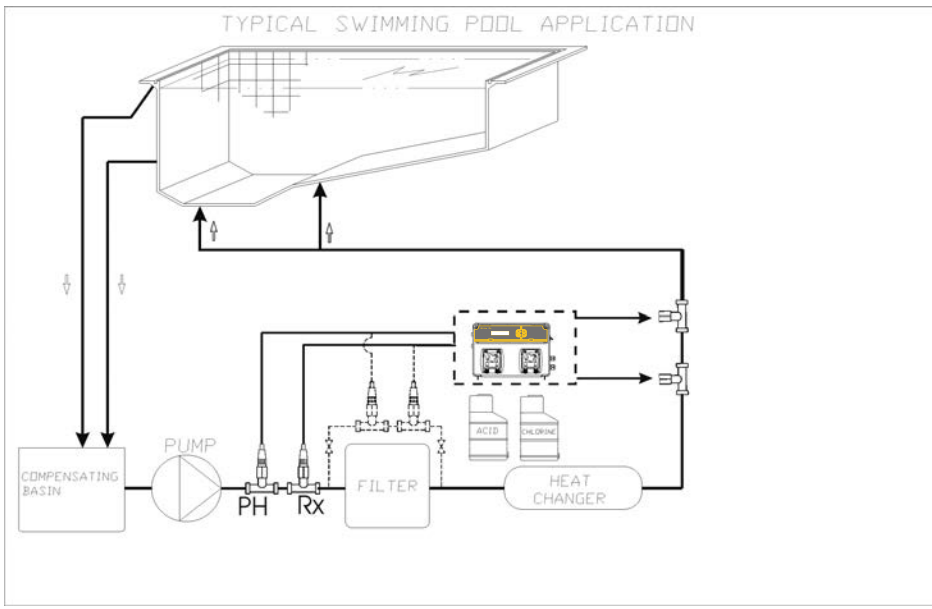

Alarm	Display	Relay	Actions to do
Level	level__7,2_ph	Alarm Relay Close	- Push Enter Key to open Alarm Relay - Restore Product tank
OFA First Alarm (time >70%)	ofa_alarm_7,2_ph	Alarm Relay open	- Push Enter Key to reset
OFA Second Alarm (time =100%)	ofa_stop__7,2_ph	Alarm Relay Close	- Push Enter Key to reset
Flow Rate	Flow_____7,2_ph	Alarm Relay open	- Restore Flow Rate
System Error	Parameter_error	Alarm Relay Open	- Press Enter Key to replace Default parameter - Destroy Unit
Calibration Function	Error_7_ph Error_4_ph Error_465_mv	Alarm Relay open	- Restore Probe or Buffer solution and repeat calibration function

- Default parameters:**
- Language = **UK**
 - Set Point value= **7,4 pH; 750 mV (Rx)**
 - Dosing Method = **Acid; Low (Rx)**
 - Time OFA = **OFF**
 - Calibration = **Full**
 - Flow Input= **OFF**

- To restore Default parameters run Following steps:**
- Power off Pool Basic unit
 - Keeping Press UP and DOWN Key switch on the Power.
 - The unit will flash **Init.default_no**
 - Press up **Init.default_Yes**
 - Enter Key to restore Default parameters.

Verpackungsinhalt

- A) pH und REDOX Steuereinheit
- B) PVC-Ansaugschlauch Crystal 4x6 (2 m)
- C) Polyethylen Druckschlauch (3 m)
- D) Schraubendübeln ($\phi = 6$ mm)
- E) Fußfilter (PVC)
- F) Rückschlagventil aus FPM (3/8" GAS)
- G) pH- und Redox- Sonden
- H) PSS3 Sondenhalterung(1/2" GAS)
- I) Montagebügel für Schlauch PSS3 2" ($\phi=50$ mm)
- L) pH 4, pH 7, 465 mV, H₂O Pufferlösungen
- M) Reduzierstück für Rückschlagventil

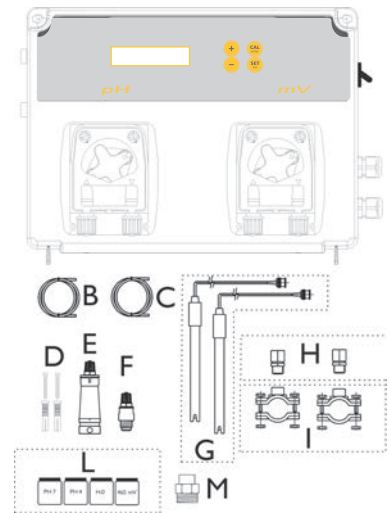

TECHNISCHE DATEN

Ausmaße (H - B - T)	234x162x108 mm
Gewicht	1 kg
Spannungsversorgung	230 VAC 50-60 Hz
Verbrauch	12 W oder 18 W
Förderleistung der Pumpe	1,5 l/Std.; 5 l/Std.
Max. Höchstdruck	1,5 bar
Pumpenaktivierung	Unterbrechung - Betrieb
Messskale	0 ÷ 14.0 pH oder Redox 0 ÷ +1000 mV
Präzision	+/- 0,1 pH; ± 10 mV
Messgenauigkeit:	±0.02 pH; ± 3 mV
Automatische Sondenkalibrierung	Automatica

Wandmontage

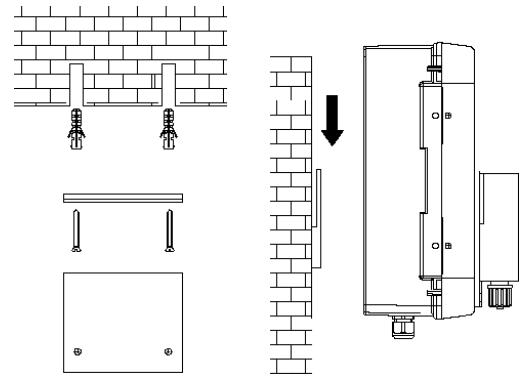



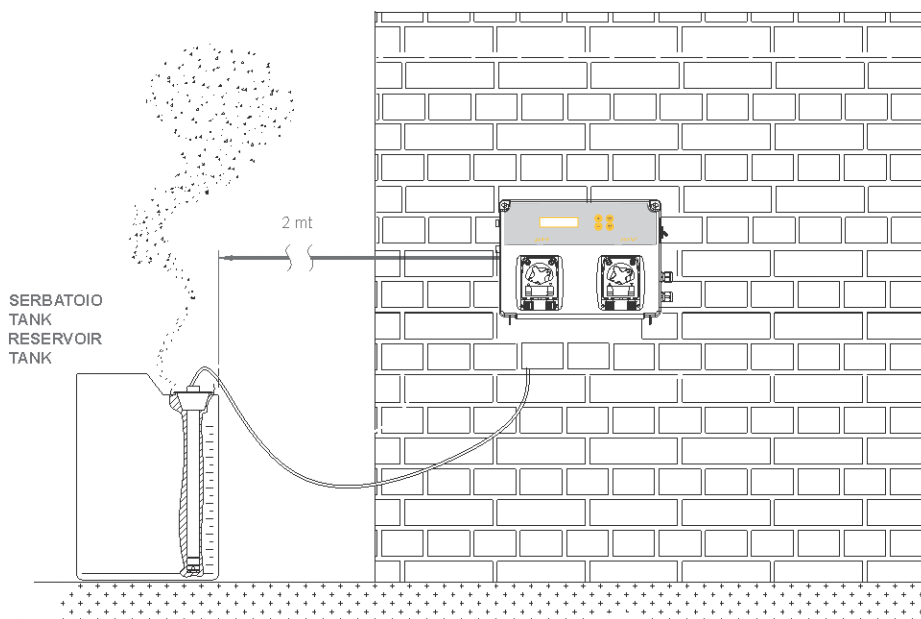

ATTENZIONE / WARNING / ATTENTION / ACHTUNG



Einstellungen

Funktionen:

-  • Kalibration (3 Sekunden lang die Taste drücken):
 - Mit den Tasten Auf oder Ab die Sonde auswählen, die kalibriert werden soll (pH oder Redox).
 - Standardfunktion zum Kalibrieren der Sonde mit der Pufferlösung 7 und 4 und 465 mV für Redox.
-  • Set Point (Taste Set drücken):
 - Die Taste Set drücken und über die Tasten Auf und Ab den Messwert auswählen. Die Taste Enter drücken, um Veränderungen vorzunehmen oder zu bestätigen.
 - **Sp_750mv__700_mv_**
 - **Sp_7.4ph__7.6_ph_**
-  • Die Tasten Kal und Set (zusammen) 5 Sekunden lang drücken, um das Programmierungs-Setup auszuführen:
 - **parameter**
 - **Sprache_** (Es können 5 Sprachen eingestellt werden EN, IT, SP, DE, FR)
 - **Rx_Messung**
 - **setpoint__750_mv** (Den Wert mit der Taste Enter und den Tasten Auf und Ab verändern). Für Redox kann ein Wert zwischen 0 und 1000 mV eingestellt werden.
 - **sp_type__low** (Den Wert LOW oder HIGH verändern)
 - **Ofa_Zeit__OFF** (Den Wert OFF oder die benötigte Zeit verändern)
 - **alr_band_100_mv** (Den Wert zwischen 100 und 300 mV verändern)
 - **pH_Messung**
 - **setpoint__7.4ph** (Den Wert mit der Taste Enter und den Tasten Auf und Ab verändern). Es kann ein Wert zwischen 0 und 14 pH eingestellt werden.
 - **sp_type__acid** (Den Wert ACID oder ALKA verändern)
 - **Ofa_Zeit__off** (Den Wert OFF oder die benötigte Zeit verändern)
 - **alr_band_1.0_ph** (Den Wert zwischen 1 pH und 3 pH verändern)
 - **Temp_25*C_**(Den Wert mit der Taste Enter und den Tasten Auf und Ab verändern). Nur pH.
 - **fluss_**(Den Wert mit der Taste Enter und den Tasten Auf oder Ab verändern).
 - Es kann aktiviert (ON) oder deaktiviert (OFF) für das Eingangssignal eingegeben werden.
 - **Kalibration_**(Den Wert mit der Taste Enter und den Tasten Auf und Ab verändern)
 - **Full** (pH 7 und 4, Redox 465 mV Pufferlösungen)
 - **Easy** (pH 7 und 4, Redox 465 mV Pufferlösungen)
 - **Aus** (Deaktiviert)
 - **Password**(Den Wert mit der Taste Enter und den Tasten Auf und Ab verändern, Standardwert **0000**)
-  • Speichern und Verlassen des Menüs mit der Taste ESC
 - **Verlassen__nein**(Den Wert mit der Taste Enter und den Tasten Auf und Ab verändern und mit Enter bestätigen)
-  • Zum Ansaugen der Pumpe die Taste Auf 3 Sekunden lang gedrückt halten und die Redox-Pumpe saugt an
 - **ansaugung__700mv**
- Zum Ansaugen der Pumpe die Taste Auf 3 Sekunden lang gedrückt halten und die pH-Pumpe saugt an
 - **ansaugung__7.2ph**
- Funktion Pumpensperre
 - Auf und Enter (zusammen) drücken, nach 5 Sekunden wird **Stopp_rx** angezeigt. Zum Entsperren erneut drücken.
 - Auf und Enter (zusammen) drücken, nach 5 Sekunden wird **Stopp_pH** angezeigt. Zum Entsperren erneut drücken.
- Das System führt eine zur Messung gegenüber dem Set-Point proportionale Dosierung aus (25% minimale Dosierung, maximale Dosierung 90% von 10 Minuten Zeit als Dosierdauer)

Anmerkungen: Das System verlässt nach 1 Minute automatisch das Menü, das System speichert keinen der Parameter.



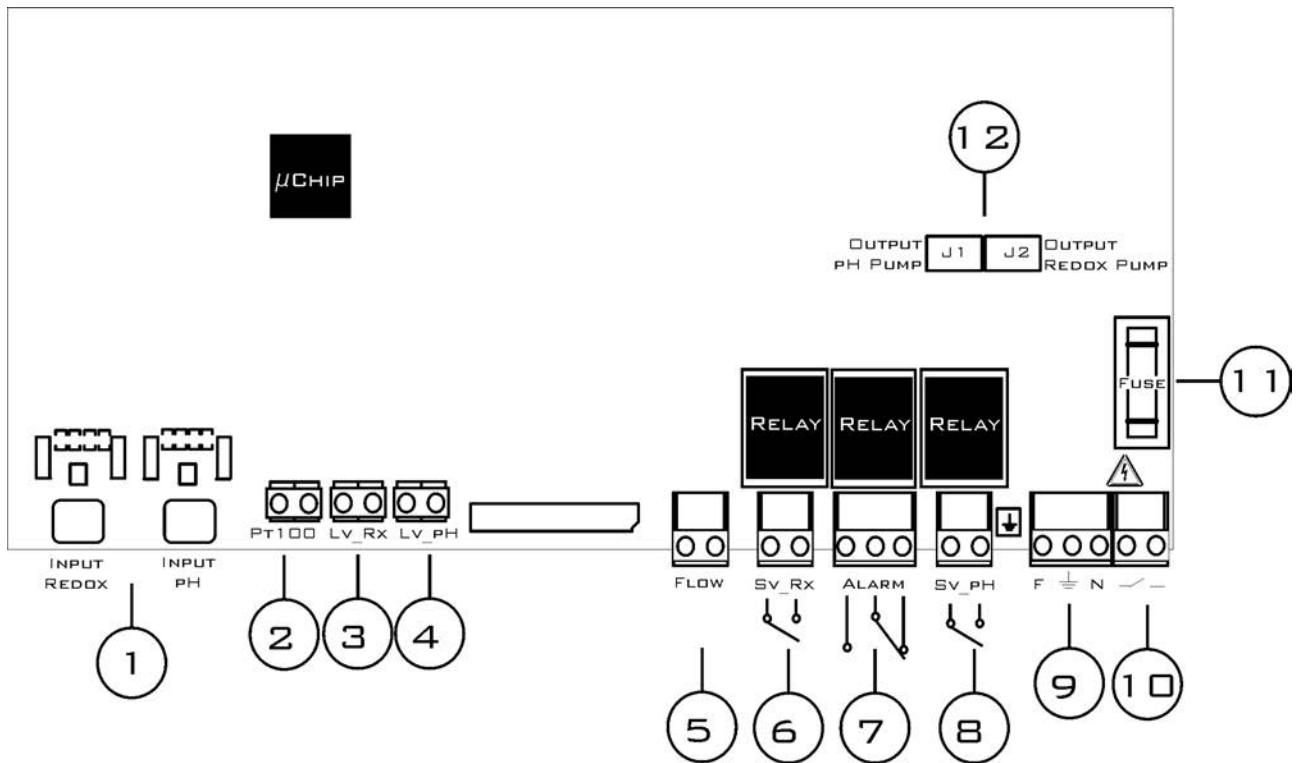







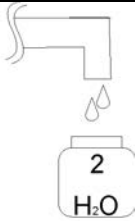

Hauptplatine



Kabelanschluss:

- 1) Eingang Sonde pH/Redox**
- 2) Eingang Temperatursonde (PT100)
- 3) Eingang Füllstandssonde Redox (Produkt im Tank)
- 4) Eingang Füllstandssonde pH (Produkt im Tank)
- 5) Eingang Zuflusssignal (Durchflussrate) [elektrisches Signal 230 Vac]
- 6) Ausgang Relais für Elektroventil Redox (Kontakt sauber, Relais 250 Vac, 10 A)
- 7) Ausgang Relais für Alarm (Kontakt sauber, Relais 250 Vac, 10 A)
- 8) Ausgang Relais für Elektroventil pH (Kontakt sauber, Relais 250 Vac, 10 A)
- 9) Stromversorgung des Systems 230 Vac 50-60 Hz.
- 10) Stromunterbrechungsschalter
- 11) 500 mA träge Sicherung
- 12) Ausgang pH-Pumpe (J1) und Redox-Pumpe (J2)

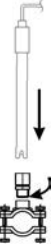





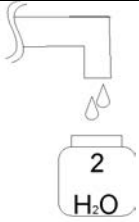

Kalibrierung der pH-Sonde

<p>①</p> 	<p>②</p> 	<p>③</p>  <p>Die Sonde spülen</p>
<p>④</p>  <p>Die Sonde in die Pufferlösung halten</p>	<p style="text-align: center;">Kalibration</p>  <p>Die Taste Kal 3 Sekunden lang drücken pH-Kalibrierung einstellen</p> <p>5</p>	<p style="text-align: center;">Kal_drucken</p>  <p>Kalibrierungsdauer 1 Minute</p> <p style="text-align: center;">60s__pause_</p> <p>6</p>
<p style="text-align: center;">7pH_Qualitat_100%</p> <p>Qualität der Sonde</p> <p>7</p>	<p>⑧</p>  <p>Die Sonde spülen</p>	<p>⑨</p>  <p>Die Sonde in die Pufferlösung halten</p>
<p style="text-align: center;">4pH_Kal_drucken</p>  <p>Kalibrierungsdauer 1 Minute</p> <p style="text-align: center;">60s__pause_</p> <p>10</p>	<p style="text-align: center;">4pH_Qualitat_100%</p> <p>Qualität der Sonde</p> <p>11</p>	<p>⑫</p>  <p>Die Sonde spülen</p>
<p>⑬</p> 	<p style="text-align: center;"></p> <p>Zum Speichern die Taste Enter drücken und die Kalibrierung verlassen</p> <p>14</p>	<p>15</p> <p>Normalzustand</p>

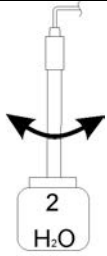
Anmerkungen

Wenn Kalibrierung = Easy eingegeben wurde, wird die Funktion für 1 Punkt erfolgen, nur Pufferlösung 7 pH.

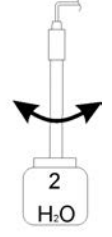
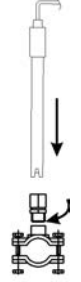
Kalibrierung der Redox-Sonde

<p>①</p> 	<p>②</p> 	<p>③</p>  <p>Die Sonde spülen</p>
<p>④</p>  <p>Die Sonde in die Pufferlösung halten</p>	<p style="text-align: center;">Kalibration</p>  <p>Die Taste Kal 3 Sekunden lang drücken Redox-Kalibrierung einstellen</p> <p>5</p>	<p>465mv_Kal_Drucken</p>  <p>Kalibrierung über 1 Minute</p> <p>60s_pause_</p> <p>6</p>
<p>465mv_Qualitat_100%</p> <p style="text-align: center;">%</p> <p>Qualität der Sonde</p> <p>7</p>	<p>⑧</p> 	<p>⑨</p> 
 <p>Die Taste Kal 3 Sekunden lang drücken</p> <p>10</p>	<p>Normalzustand</p> <p>11</p>	

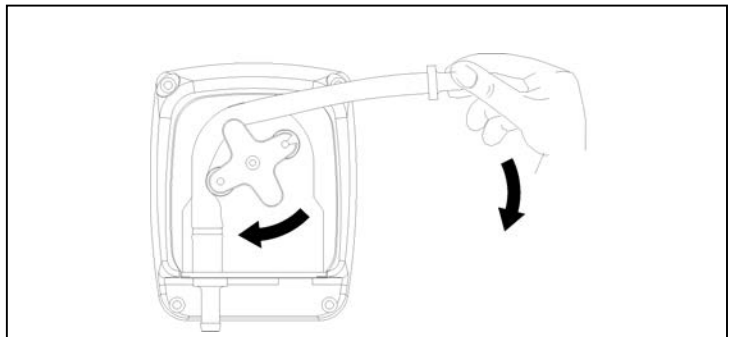
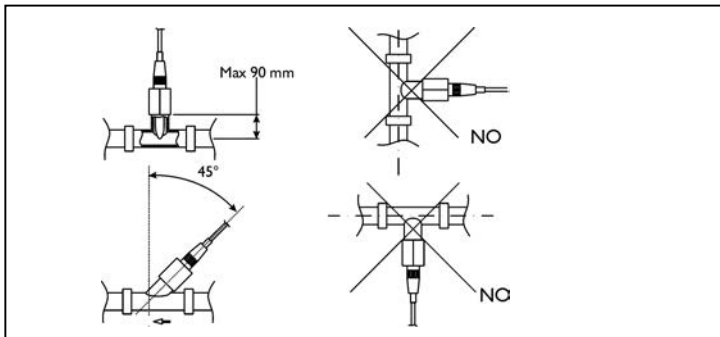
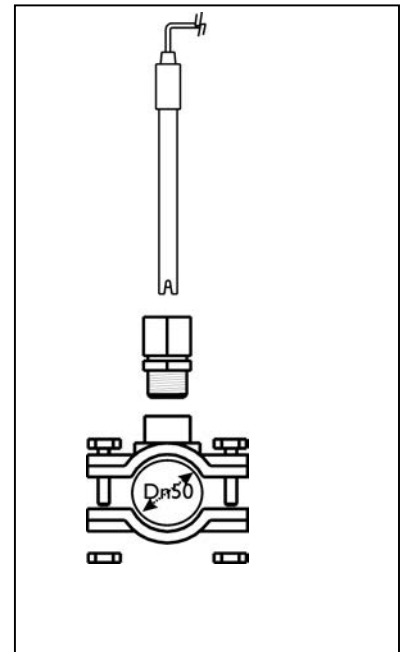
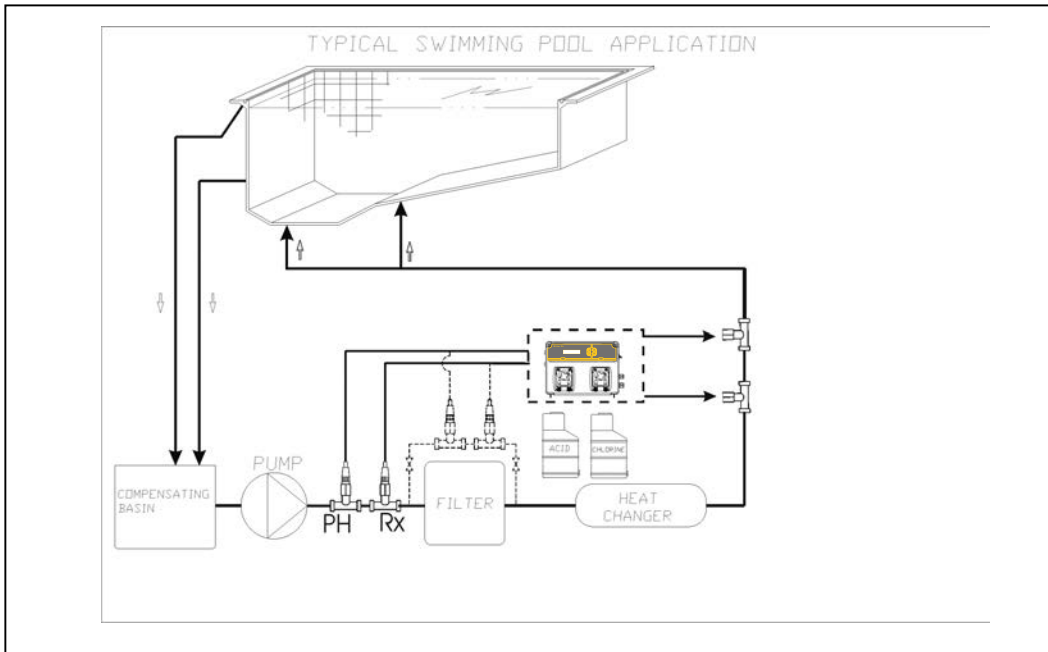

Alarm	Display	Relais	Abhilfe
Füllstandsalarm	Fullstand_7,2_ph Fullstand_720_mv	Alarm Relais geschlossen	- Die Taste Enter drücken, um das Alarmrelais zu öffnen - Produkt im Produkttank auffüllen
Erster OFA-Alarm (Zeit >70%)	alr_ofa_7,2_ph	Alarm Relais geöffnet	- Enter drücken, um ein Reset durchzuführen
Zweiter OFA-Alarm (Zeit >100%)	stop_ofa__7,2_ph	Alarm Relais geschlossen	- Enter drücken, um ein Reset durchzuführen
Durchfluss	Durchfluss___7,2_ph	Alarm Relais geöffnet	- Durchfluss wieder herstellen
Systemfehler	Parameter_error	Alarm Relais geöffnet	- Enter drücken, um die Werkseinstellungen wieder herzustellen - Einheit kaputt
Kalibrierungsfehler	Falsch_7_ph Falsch_4_ph Falsch_465_mv	Alarm Relais geöffnet	- Sonde oder Pufferlösung austauschen und die Kalibrierung durchführen

- Werksparemeter:**
- Sprache = **UK**
 - SetPoint Wert = **7,4 pH; 750 mV (Rx)**
 - Dosiermethode = **Acid; Low (Rx)**
 - OFA-Zeit = **OFF**
 - Kalibrierung = **Full**
 - Durchflusseingang = **OFF**

- Um die Werkseinstellungen wieder herzustellen:**
- Das System ausschalten
 - Die Tasten AUF und AB zusammen gedrückt halten und das System einschalten.
 - Das System zeigt folgendes an: **Initial_storung_no**
 - AUF drücken **Initial_storung_Yes**
 - Enter drücken, um die Werkseinstellungen wieder herzustellen

Contenido del embalaje:

- A) Unidad de control pH y REDOX
- B) Tubo de aspiración en PVC Crystal 4x6 (2 m)
- C) Tubo de envío en polietileno (3m)
- D) Tornillos con tacos ($\phi = 6$ mm)
- E) Filtro de fondo (PVC)
- F) Válvula de retención en FPM (3/8" GAS)
- G) Sondas pH y Redox
- H) PSS3 porta sonda (1/2" GAS)
- I) Soporte de montaje para PSS3 para tubo de 2 pulgadas ($\phi=50$ mm)
- L) pH 4, pH 7, 465 mV, H₂O soluciones tampón
- M) Reducción para la válvula antirretorno

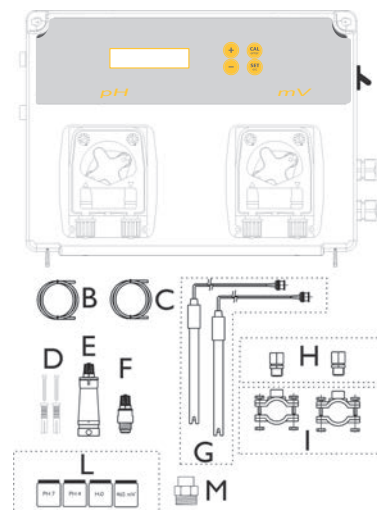

Montaje en pared

CARACTERÍSTICAS TÉCNICAS

Dimensiones (A – A– L)	234x162x108 mm
Peso	1 kg
Alimentación	230 VCA 50-60 Hz
Consumo	12 W o 18 W
Caudal bomba	1,5 l/h; 5 l/h
Presión máxima	1,5 bar
Accionamiento de la bomba	Pausas - Trabajo
Escala de medida	0÷14,0 pH; Redox 0÷+1000 mV
Precisión	+/-0,1 pH; ±10 mV
Precisión	±0,02 pH; ± 3 mV
Calibración sonda	Automática

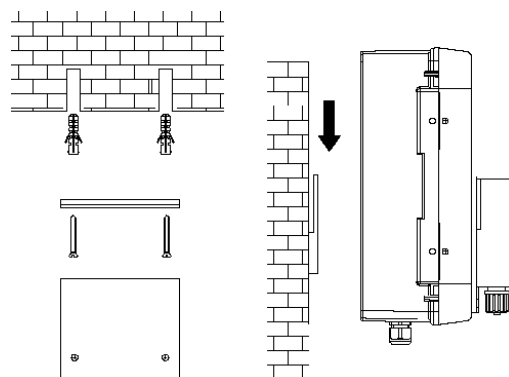



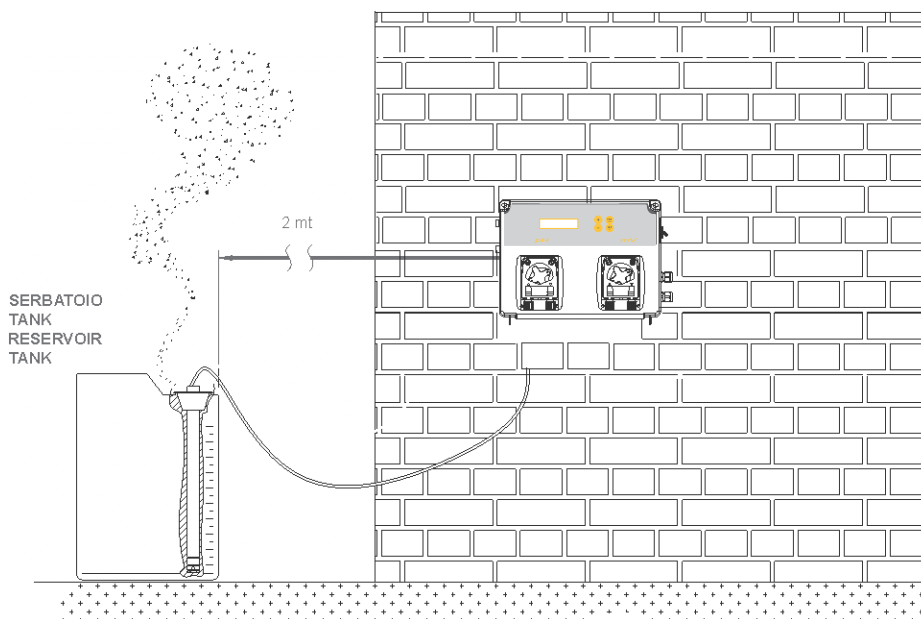

ATENCIÓN



Configuraciones

Funciones:

-  • Calibración (Pulsar la tecla Cal por 3 segundos):
 - Seleccionar la sonda a calibrar pH o Redox con las teclas Arriba o Abajo.
 - Función Estándar de calibración de la sonda con la solución tampón 7 y 4 y 465 mV para el Redox.
-  • Punto de Ajuste (Pulsar la tecla Ajs):
 - Pulsar la tecla Ajs y seleccionar la medida utilizando las teclas Arriba y Abajo, pulsar la tecla Intro para modificar y confirmar.
 - **Sp_750mv__700_mv_**
 - **SP_7.4ph__7.6_ph_**
-  • Pulsar las teclas Cal y Ajs (juntas) por 5 segundos y se ejecutará la Configuración de programación:
 - **programacion**
 - **Idioma_** (Se puede elegir entre 5 idiomas disponibles (EN, IT, SP, DE, FR))
 - **Medida_Redox**
 - **setpoint__750_mv** (Modificar el valor con la tecla Intro y las teclas Arriba y Abajo) Se puede configurar el valor entre 0 y 1000 mV para Redox
 - **dosif.__bajo**(Modificar valor BAJO o ALTO)
 - **tiempo_ofa__OFF** (Modificar el valor OFF o el Tiempo necesario)
 - **alr_band_100_rx** (Modificar el valor de 100 a 300 mV)
 - **setpoint_ph**
 - **Setpoint__7.4ph** (Modificar el valor con la tecla Intro y las teclas Arriba y Abajo) Se puede configurar el valor entre 0 y 14 pH
 - **Dosif.__acido**(Modificar valor ÁCIDO o ALCALINO)
 - **tiempo_ofa__off** (Modificar el valor OFF o el Tiempo necesario)
 - **alr_band_1.0_ph** (Modificar el valor de 1 pH a 3 pH)
 - **Temp_25*C_**(Modificar el valor con la tecla Intro y las teclas Arriba y Abajo) sólo pH.
 - **Flujo_**(Modificar el valor con la tecla Intro y las teclas Arriba o Abajo)
 - Se puede programar Habilitado (On) o Deshabilitado (OFF) para la señal de entrada.
 - **Calibracion**(Modificar el valor con la tecla Intro y las teclas Arriba y Abajo)
 - **Full** (pH 7 y 4, Redox 465 mV Soluciones tampón)
 - **Easy** (pH 7, Redox 465 mV Soluciones tampón)
 - **Off** (Deshabilitado)
 - **Password**(Modificar el valor con la tecla Intro y las teclas Arriba y Abajo, valor estándar **0000**)
 - Guardar y salir del Menú con la tecla SAL
 - **Salin__no/SI**(Modificar el valor con la tecla Intro y las teclas Arriba y Abajo y confirmar con Intro)
 -  • Cebado Bomba mantener pulsada la tecla Arriba para 3 segundos y la bomba Redox empieza el cebado
 - **cebado__700mv**
 - Cebado Bomba mantener pulsada la tecla Arriba para 3 segundos y la bomba pH empieza el cebado
 - **cebado__7.2ph**
 - Función Bloqueo Bombas
 - Pulsar Arriba e Intro (juntas), al cabo de 5 segundos se visualiza **paro_Rx** pulsar nuevamente para desbloquear
 - Pulsar Arriba e Intro (juntas), al cabo de 5 segundos se visualiza **paro_ph** pulsar nuevamente para desbloquear
 - El sistema efectúa una dosificación proporcional a la medida con respecto al Punto de Ajuste (25% dosificación mínima, dosificación máxima 90% de 10 minutos de tiempo como periodo de dosificación)

Notas: El sistema sale automáticamente del Menú al cabo de 1 minuto de tiempo, el sistema no guarda ningún parámetro.



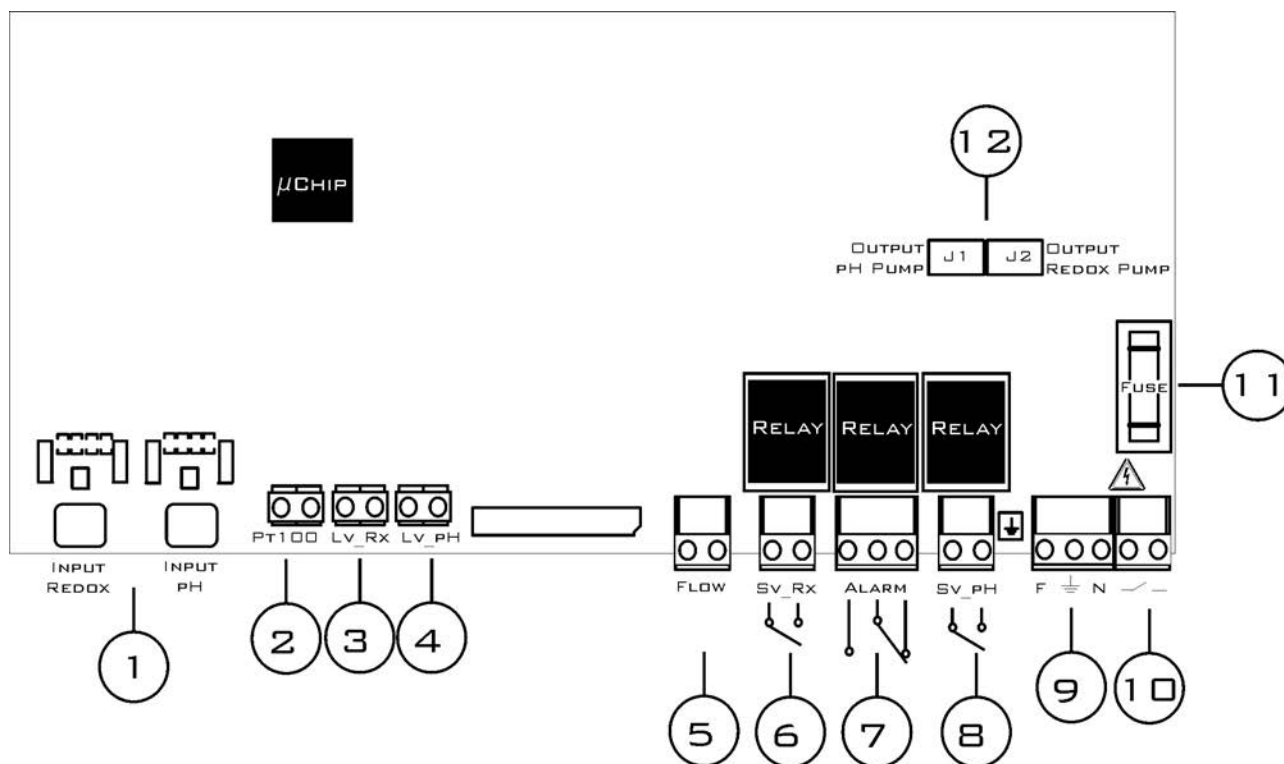







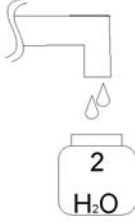

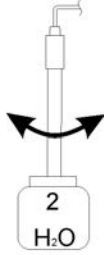
Placa principal



Conexión cables:

- 1) Entrada sonda pH y Redox
- 2) Entrada sonda Temperatura (PT100)
- 3) Entrada sonda Nivel Redox (Producto en el depósito)
- 4) Entrada sonda Nivel pH (Producto en el depósito)
- 5) Entrada señal Flujo (Caudal) [Señal eléctrica 230 Vca]
- 6) Salida Relé para Electroválvula Redox (Contacto limpio, Relé 250 Vca 10 A)
- 7) Salida Relé para Alarma (Contacto limpio, Relé 250 Vca 10 A)
- 8) Salida Relé para Electroválvula pH (Contacto limpio, Relé 250 Vca 10 A)
- 9) Alimentación sistema 230 Vca 50-60 Hz
- 10) Interruptor de alimentación
- 11) Fusible 500mA retardado
- 12) Salida bomba pH (J1) y bomba Redox (J2)

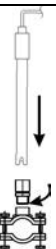





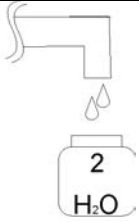

Calibración sonda pH

 <p>1</p>	 <p>2</p>	 <p>3</p> <p>Lavar la sonda</p>
 <p>4</p> <p>Conservar la sonda en la solución tampón</p>	<p>Calibracion</p>  <p>Pulsar la tecla Cal por 3 segundos programar calibración pH</p> <p>5</p>	<p>Pulsar_cal</p>  <p>Duración calibración 1 minuto</p> <p>Esperere__60s_</p> <p>6</p>
<p>7pH_Calidad_100%</p> <p>Calidad sonda</p> <p>7</p>	 <p>8</p> <p>Lavar la sonda</p>	 <p>9</p> <p>Conservar la sonda en la solución tampón</p>
<p>4pH_Pulsar_cal</p>  <p>Duración calibración 1 minuto</p> <p>Esperere__60s_</p> <p>10</p>	<p>4pH_Calidad_100%</p> <p>Calidad Sonda</p> <p>11</p>	 <p>12</p> <p>Lavar la sonda</p>
 <p>13</p>	 <p>Pulsar tecla Intro guardar salir</p> <p>14</p>	<p>15</p> <p>Estado Normal</p>

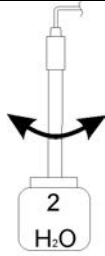
Notas:

Si ha sido configurado Calibración = Fácil la función será para 1 punto, sólo solución tampón 7 pH.

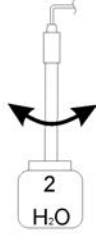
Calibración sonda Redox

<p>①</p> 	<p>②</p> 	<p>③</p>  <p>Lavar la sonda</p>
<p>④</p>  <p>Conservar la sonda en la solución tampón</p>	<p style="text-align: center;">Calibración</p>  <p>Pulsar la tecla Cal por 3 segundos programar calibración Redox</p> <p>5</p>	<p style="text-align: center;">465mv_Pulsar_cal</p>  <p>Duración calibración 1 minuto</p> <p style="text-align: center;">espere_60s_</p> <p>6</p>
<p style="text-align: center;">465mv_Calidad_100%</p> <p style="text-align: center;">Calidad Sonda</p> <p>7</p>	<p>⑧</p> 	<p>⑨</p> 
 <p>Pulsar la tecla Cal por 3 segundos</p> <p>10</p>	<p style="text-align: center;">Estado Normal</p> <p>11</p>	

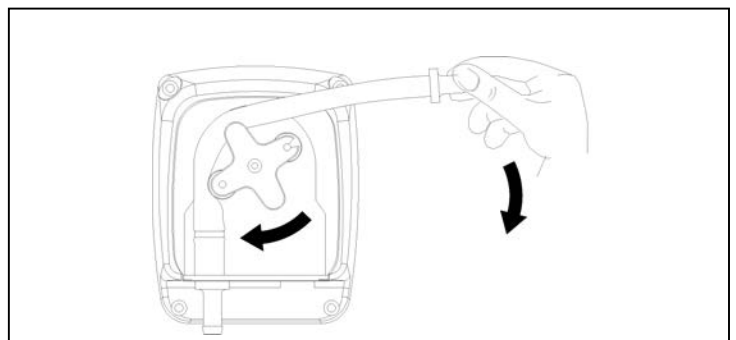
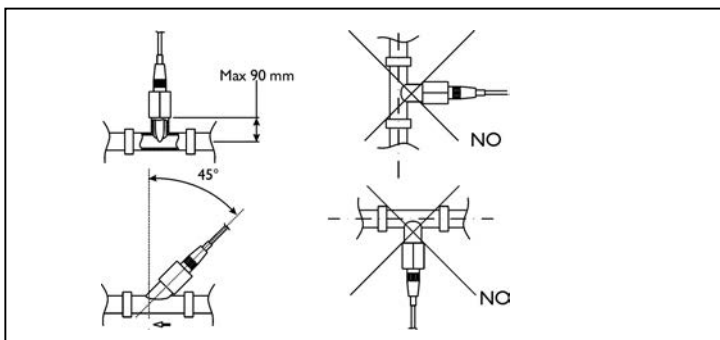
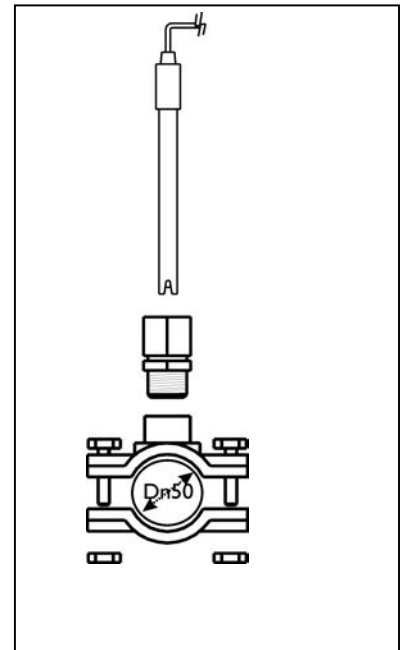
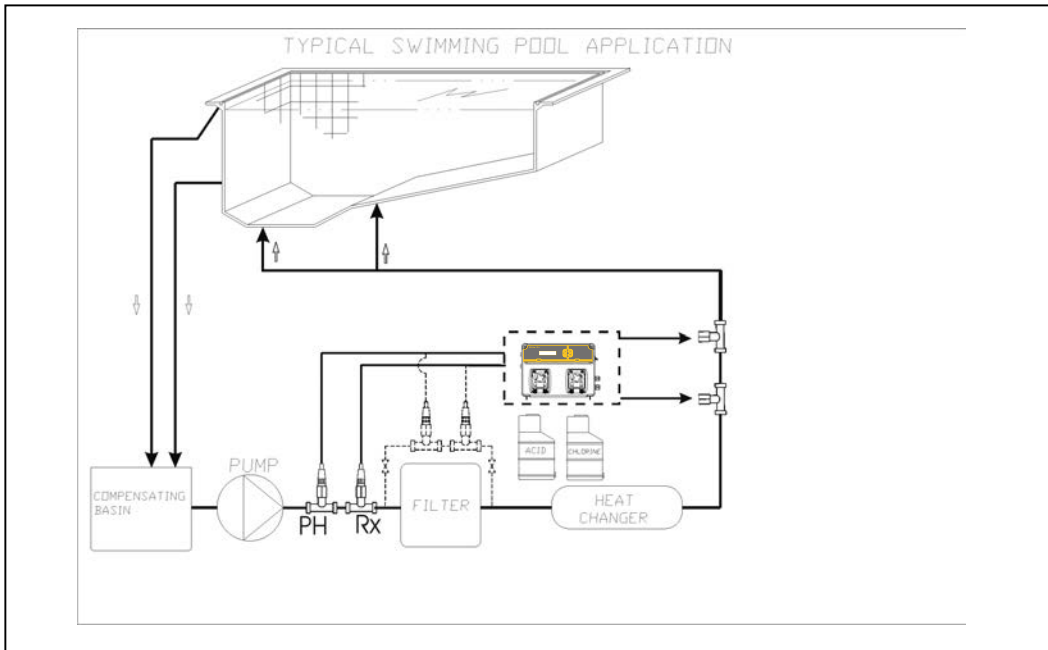

Alarma	Display	Relé	Acción a efectuar
Nivel	nivel_7,2_ph nivel_720_mv	Alarma Relé Cerrada	- Pulsar la tecla Intro para abrir Alarma Relé - Restablecer el producto en el depósito
OFA Primera Alarma (tiempo > 70%)	alr_ofa_7,2_ph	Alarma Relé Abierta	- Pulsar Intro para restablecer
OFA Segunda Alarma (tiempo = 100%)	paro_ofa_7,2_ph	Alarma Relé Cerrada	- Pulsar Intro para restablecer
Flujo	caudal_7,2_ph	Alarma Relé Abierta	- Restablecer Flujo
Error de Sistema	Parameter_error	Alarma Relé Abierta	- Pulsar Intro para restablecer parámetros predefinidos - Unidad rota
Error Calibración	Incorrecto_7_ph Incorrecto_4_ph Incorrecto_465_mv	Alarma Relé Abierta	- Sustituir sonda o solución tampón y efectuar la calibración

- Parámetros de fábrica:**
- Idioma = **UK**
 - Valor Punto de Ajuste = **7,4 pH; 750 mV (Rx)**
 - Método Dosificación = **Ácido bajo (Rx)**
 - Tiempo OFA = **OFF**
 - Calibración = **Lleno**
 - Entrada Flujo = **OFF**

- Para restablecer los parámetros de fábrica:**
- Apagar el sistema
 - Mantener pulsadas las teclas Arriba y Abajo juntas y poner en marcha el sistema.
 - El sistema visualizará **Init.default_no**
 - Pulsar ARRIBA **Init.default_Yes**
 - Pulsar la tecla Intro para restablecer los parámetros de fábrica.

Contenu de l'emballage :

- A) Unité de contrôle pH - RÉDOX
- B) Tuyau d'aspiration PVC Crystal 4x6 (2 m)
- C) Tuyau de refoulement en Polyéthylène (3m)
- D) Chevilles ($\phi = 6$ mm)
- E) Filtre d'aspiration (PVC)
- F) Clapet anti-retour en Viton FPM (3/8" GAZ)
- G) Sondes pH et Rédox
- H) PSS3 porte-sonde (1/2" GAZ)
- I) Bride de montage pour tuyau PSS3 2" pouces ($\phi=50$ mm)
- L) Kit solutions tampon pH 4, pH 7, 465 mV, H₂O
- M) Raccord pour clapet anti-retour

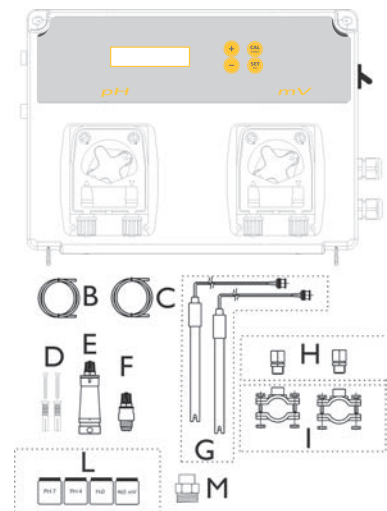

Fixation murale

CARACTERISTIQUES TECHNIQUES

Dimensions (A – L – P)	234x162x108 mm
Poids	1 kg
Alimentation	230 Vc.a. 50-60 Hz
Consommation	12 W ou 18 W
Débit de la pompe	1,5 l/h ; 5 l/h
Pression maximale	1,5 bar
Actionnement pompe	Activation - Pause
Échelle de mesure	0 ÷ 14,0 pH ou Redox 0 ÷ +1000 mV
Précision	+/- 0,1 pH; ±10 mV
Exactitude	±0,02 pH ; ± 3 mV
Étalonnage sonde	Automatique

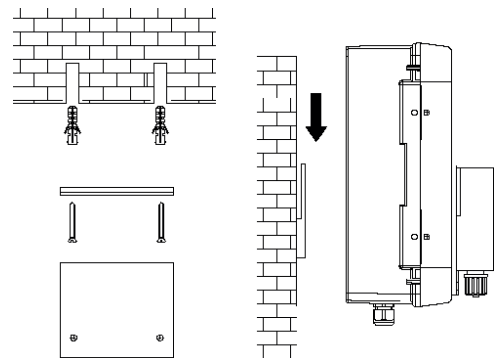

ATTENZIONE / WARNING / ATTENTION / ACHTUNG

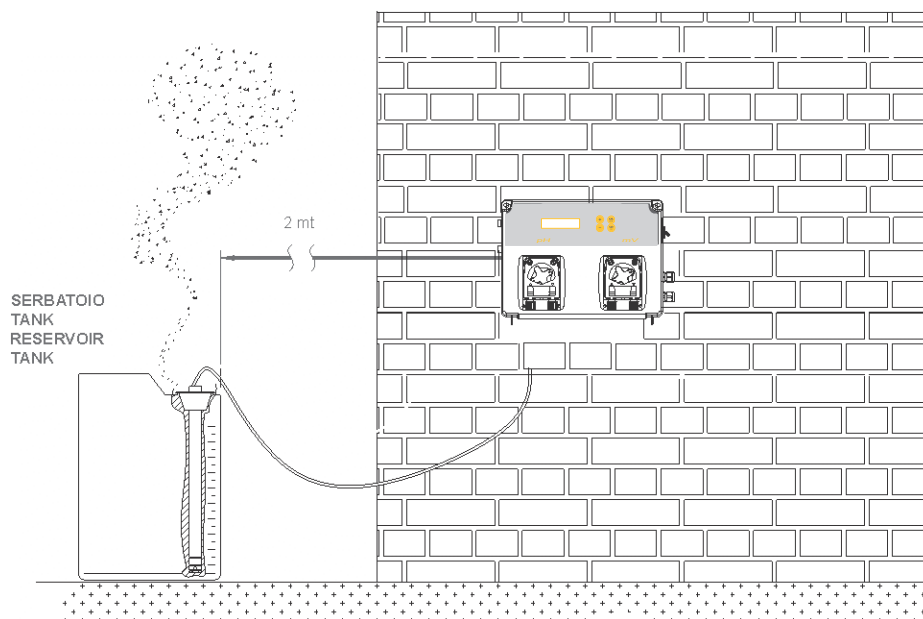

Réglages

Fonctions :



- Étalonnage (Appuyer sur la touche Cal pendant 3 secondes) :
 - Sélectionner la sonde à étalonner, pH ou potentiel Rédox, à l'aide des touches flèche Haut ou flèche Bas.
 - Fonction Standard d'étalonnage de la sonde avec la solution tampon 7 et 4 et 465 mV pour le potentiel Rédox.



- Set Point ou point de consigne (appuyer sur la touche Set) :
 - Appuyer sur la touche Set et sélectionner la mesure à l'aide des touches flèche Haut et flèche Bas; appuyer sur la touche Enter pour modifier et valider.
 - **Sp_750mv__700_mv_**
 - **Sp_7.4ph__7.6_ph_**



- Appuyer sur les touches Cal et Set (en même temps) pendant 5 secondes pour activer le Setup de configuration :



- **menu**
 - **Langue_** (On peut sélectionner l'une des 5 langues disponibles (EN, IT, SP, DE, FR))
 - **Mesure_Redox**
 - **setpoint__750_mv** (Modifier la valeur avec la touche Enter et les touches flèche Haut et flèche Bas) Pour le potentiel Rédox, on peut saisir une valeur entre 0 et 1000 mV.
 - **Dosage__bas** (Modifier la valeur BAS ou HAUT)
 - **temps_ofa__OFF** (Modifier la valeur OFF ou le Temps nécessaire)
 - **ALR_BAnd_100_rx** (Modifier la valeur de 100 à 300 mV)
 - **Mesure_pH**
 - **setpoint__7.4ph** (Modifier la valeur par la touche Enter et les flèches Haut et Bas) Pour le pH, on peut saisir une valeur entre 0 et 14.
 - **Dosage__acide** (Modifier la valeur ACID ou ALKA)
 - **temps_ofa__OFF** (Modifier la valeur OFF ou le temps nécessaire)
 - **alr_band_1.0_ph** (Modifier la valeur de 1 pH à 3 pH)
 - **Temp_25*C_**(modifier la valeur par la touché Enter et les flèches Haut et Bas) uniquement pH.
 - **Debit_**(modifier la valeur par la touche Enter et les flèches Haut et Bas)
 - Le signal d'entrée peut être sélectionné comme Activé (ON) ou Désactivé (OFF).
 - **calibrage**(modifier la valeur par la touche Enter et les flèches Haut et Bas)
 - **full**(Kit solutions tampon pH 4, pH 7, Rédox 465 mV)
 - **easy**(Kit solutions tampon pH 7, Rédox 465 mV)
 - **Off** (Désactivé)
 - **password**(modifier la valeur par la touche Enter et les flèches Haut et Bas, valeur standard **0000**)



- Enregistrement et sortie du Menu avec la touche ESC.
 - **exit__non** (modifier la valeur par la touche Enter et les flèches Haut et Bas et confirmer par Enter)
- Pour l'amorçage de la pompe, maintenir la touche flèche HAUT appuyée pendant 3 secondes et la pompe Rédox amorce
 - **Amorçage__700mV**
- Pour l'amorçage de la pompe, maintenir la touche flèche HAUT appuyée pendant 3 secondes et la pompe pH amorce
 - **amorçage__7.2pH**
- Fonction Arrêt Pompe
 - Appuyer sur flèche Haut et sur Enter (en même temps) ; après 5 secondes, l'afficheur visualise **Stop_RX**. Appuyer de nouveau sur les touches pour remettre en marche.
 - Appuyer sur flèche Haut et sur Enter (en même temps) ; après 5 secondes, l'afficheur visualise **Stop_pH**. Appuyer de nouveau sur les touches pour remettre en marche.
- Le système exécute un dosage proportionnel à la mesure par rapport au Point de consigne. (25% dosage minimum, 90% dosage maximum de 10 minutes)

Remarque : Le système quitte automatiquement le Menu après 1 minute de temps, sans enregistrer aucun paramètre.



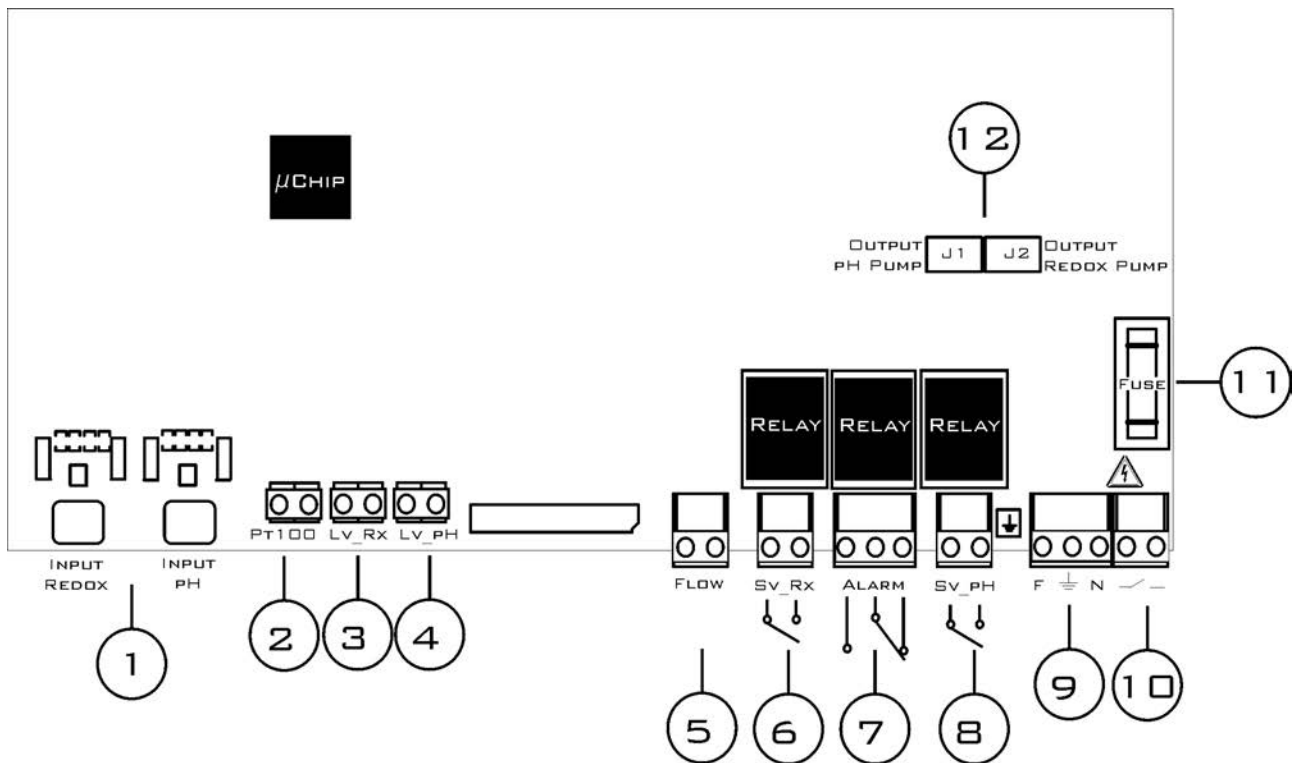







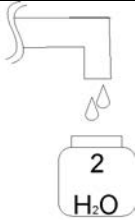

Panneau de commande

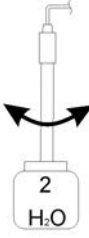

Connexion des cables:

- 1) Entrée sonde pH et Redox
- 2) Entrée sonde température (PT100)
- 3) Entrée sonde Niveau Redox (Produit dans le bidon)
- 4) Entrée sonde Niveau pH (Produit dans le bidon)
- 5) Entrée signal débit (Flow Rate) [signal électrique 230 Vc.a.]
- 6) Sortie Relais Alarme pour électrovanne Redox (Contact libre, Relais 250 Vc.a. 10 A)
- 7) Sortie Relais Alarme pour électrovanne (Contact libre, Relais 250 Vc.a. 10 A)
- 8) Sortie Relais Alarme pour électrovanne pH (Contact libre, Relais 250 Vc.a. 10 A)
- 9) Alimentation système : 230 Vc.a. 50/-60 Hz
- 10) Interrupteur d'alimentation
- 11) Fusible 500 mA retardé
- 12) Sortie pompe pH (J1) et pompe Redox (J2)

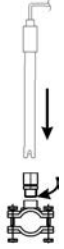





Étalonnage Sonde pH

<p>①</p> 	<p>②</p> 	<p>③</p>  <p>Laver la sonde</p>
<p>④</p>  <p>Maintenir la sonde dans la solution tampon</p>	<p style="text-align: center;">calibrage</p>  <p>Appuyer sur la touche Cal pendant 3 secondes Régler étalonnage pH.</p> <p>5</p>	<p style="text-align: center;">presser_cal</p>  <p>Durée Étalonnage 1 minute</p> <p style="text-align: center;">patienter__60_s_</p> <p>6</p>
<p style="text-align: center;">7pH_Qualite'_100%</p> <p>Qualité de la sonde</p> <p>7</p>	<p>⑧</p>  <p>Laver la sonde</p>	<p>⑨</p>  <p>Maintenir la sonde dans la solution tampon</p>
<p style="text-align: center;">4pH_presser_cal</p>  <p>Durée Étalonnage 1 minute</p> <p style="text-align: center;">patienter__60_s_</p> <p>10</p>	<p style="text-align: center;">4pH_Qualite'_100%</p> <p>Qualité de la sonde</p> <p>11</p>	<p>⑫</p>  <p>Laver la sonde</p>
<p>⑬</p> 	 <p>Appuyer sur la touche Enter, enregistrer, puis quitter</p> <p>14</p>	<p>15</p> <p style="text-align: center;">État Normal</p>

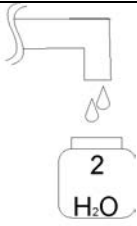
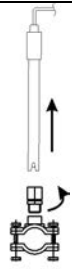
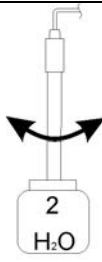
Remarque :

Quand la fonction EASY CAL (étalonnage facile) est sélectionnée, l'étalonnage s'effectue uniquement pour 1 point 7 pH.

Étalonnage sonde Redox

<p>①</p> 	<p>②</p> 	<p>③</p>  <p>Laver la sonde</p>
<p>④</p>  <p>Maintenir la sonde dans la solution tampon</p>	<p style="text-align: center;">calibrage</p>  <p>Appuyer sur la touche Cal pendant 3 secondes Régler étalonnage Redox</p> <p>5</p>	<p>465mv_presser_cal</p>  <p>Durée Étalonnage 1 minute</p> <p>patienter_60 s_</p> <p>6</p>
<p>465mv_Qualite'_100 %</p> <p>Qualité de la sonde</p> <p>7</p>	<p>⑧</p> 	<p>⑨</p> 
 <p>Appuyer sur la touche Cal pendant 3 secondes</p> <p>10</p>	<p>État Normal</p> <p>11</p>	

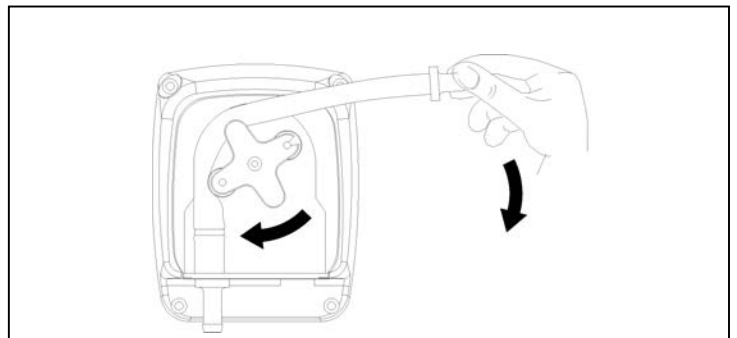
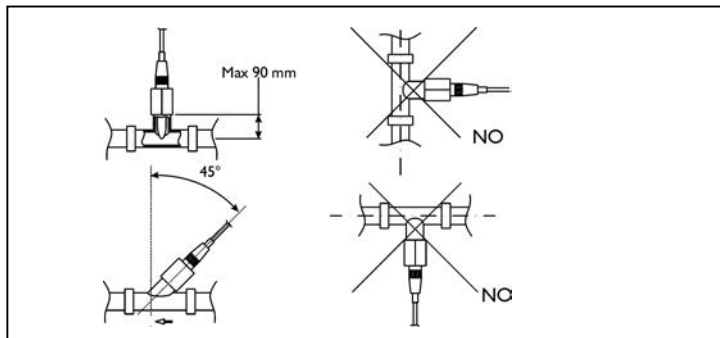
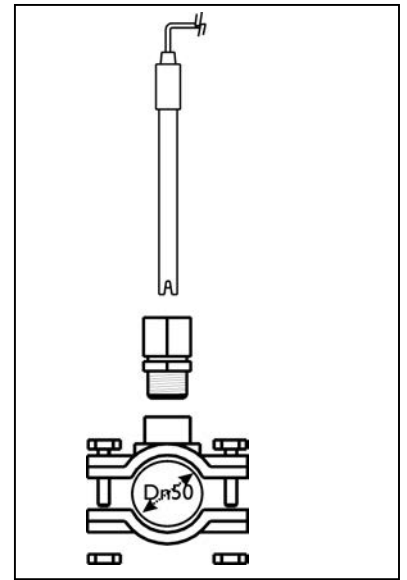
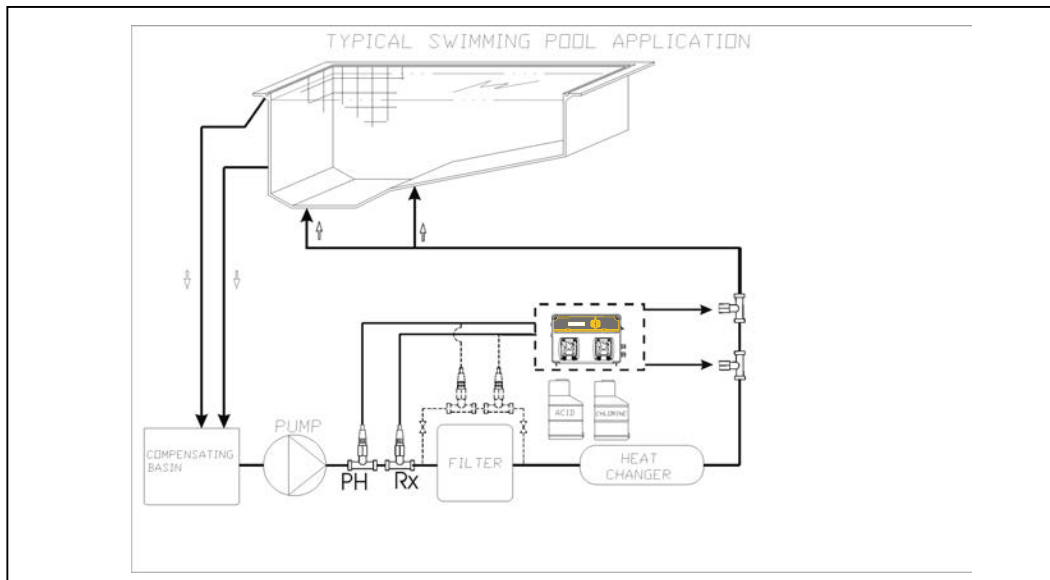

Alarme	Écran	Relais	Action à exécuter
Niveau	niveau__7,2_ph niveau__720_mv	Alarme relais fermé	- Appuyer sur la touche Enter pour activer alarme relais - Rétablir le niveau de produit dans le récipient
OFA Première Alarme (temps >70%)	Alr_ofa__7,2_ph	Alarme relais ouvert	- Appuyer sur Enter pour réinitialiser
OFA deuxième Alarme (temps >100%)	Stop_ofa__7,2_ph	Alarme relais fermé	- Appuyer sur Enter pour réinitialiser
Débit	Debit___7,2_ph	Alarme relais ouvert	- Rétablir le flux
Erreur de système	parameter_error	Alarme relais ouvert	- Appuyer sur Enter pour restaurer les paramètres par défaut - Unité endommagée
Erreur d'étalonnage	Erreur_7_pH Erreur_4_pH Erreur_465_mv	Alarme relais ouvert	- Remplacer la Sonde ou la Solution tampon et répéter l'étalonnage.

Paramètres d'usine :

- Langue = **UK**
- Point de consigne valeur = **7,4 pH; 750 mV (Rx)**
- Méthode Dosage = **Acide; Bas (Rx)**
- Temps OFA = **OFF**
- Étalonnage = **Pleine échelle**
- Entrée Flux= **OFF**

Pour restaurer les paramètres par défaut :

- Arrêter le système
- Maintenir les touches flèches Haut et Bas (en même temps) appuyées et allumer le système.
- Le Système affiche **RAZ_default_non**
- Appuyer sur flèche HAUT **RAZ_default_Oui**
- Appuyer sur la touche Enter pour restaurer les paramètres par défaut.

Contenuto nell'imballo:

- A) pH and REDOX unità di controllo
- B) PVC Crystal 4x6 tubo aspirazione (2 m)
- C) Polyethylene tubo mandata (3m)
- D) Tasselli a vite ($\phi=6$ mm)
- E) Filtro di fondo (PVC)
- F) FPM valvola di non ritorno (3/8" GAS)
- G) Sonde pH e Redox
- H) PSS3 porta sonda (1/2" GAS)
- I) Staffa di montaggio per PSS3 per tubo 2 pollici ($\phi=50$ mm)
- L) pH 4, pH 7, 465 mV, H₂O soluzioni tampone
- M) Riduzione per valvola di non ritorno

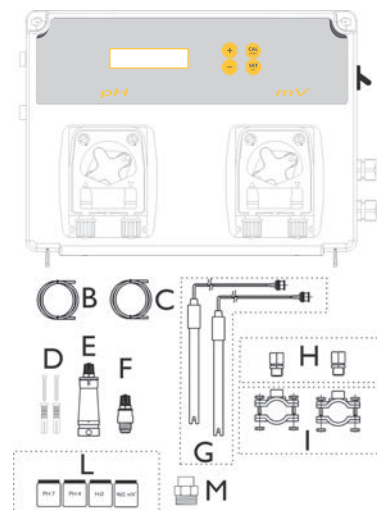

Montaggio parete

CARATTERISTICHE TECNICHE

Dimensioni (H – W – L)	234x162x108 mm
Peso	1 kg
Alimentazione	230 VAC 50-60Hz
Consumo	12 W or 18 W
Portata pompa	1,5 l/h; 5 l/h
Pressione Massima	1,5 bar
Azionamento pompa	Pause - Lavoro
Scala Misura	0 ÷ 14.0 pH; Redox 0÷ +1000 mV
Precisione	+/- 0,1 pH; ± 10 mV
Accuratezza	±0.02 pH; ± 3 mV
Calibrazione sonda	Automatica

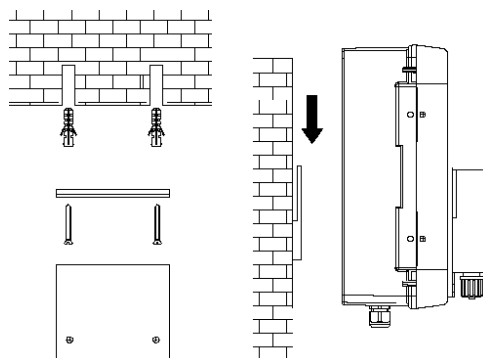

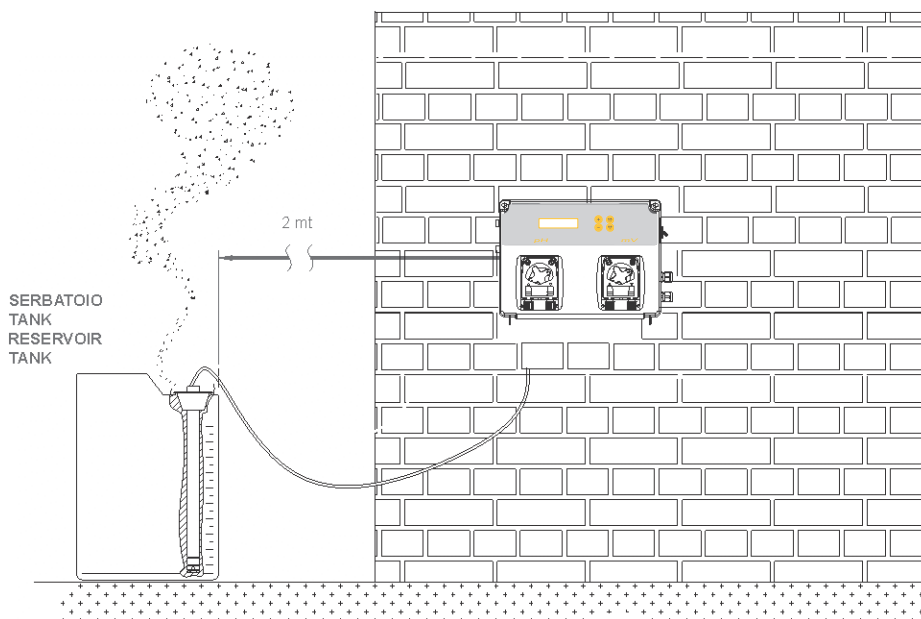

ATTENZIONE / WARNING / ATTENTION / ACHTUNG



Impostazioni

Funzioni:

-  • Calibrazione (Premere tasto Cal per 3 Secondi):
 - Selezionare la sonda da calibrare pH o Redox con i tasti Su o Giù.
 - Funzione Standard di calibrazione della sonda con la soluzione tampone 7 e 4 e 465 mV per il Redox.
-  • Set Point (Premere il tasto Set):
 - Premere il tasto Set e selezionare la misura tramite i tasti Su e Giù premere il tasto Enter per modificare e confermare.
 - **Sp_750mv__700_mv_**
 - **Sp_7.4ph__7.6_ph_**
- Premere i tasti Cal e Set (insieme) per 5 Secondi si eseguirà il Setup di programmazione:
 - **nemu**
 - **Lingua_** (Si può selezionare una lingua tra le 5 disponibili (EN, IT, SP, DE, FR))
 - **Misura_Redox**
 - **setpoint__750_mv** (Modificare il valore con tasto Enter e tasti Su e Giù) Si può impostare il valore tra 0 e 1000 mV per Redox
 - **sp_type__low** (Modificare valore LOW o HIGH)
 - **tempo_ofa__OFF** (Modificare valore OFF o il Tempo necessario)
 - **alr_band_100_rx** (Modificare valore da 100 a 300 mV)
 - **Misura_ph**
 - **setpoint__7.4ph** (Modificare il valore con tasto Enter e tasti Su e Giù) Si può impostare il valore tra 0 e 14 pH
 - **sp_type__acid** (Modificare valore ACID or ALKA)
 - **tempo_ofa__off** (Modificare valore OFF o il Tempo necessario)
 - **alr_band_1.0_ph** (Modificare valore da 1 pH a 3 pH)
 - **Temp_25*C_**(Modificare valore con tasto Enter e tasti Su e Giù) solo pH.
 - **Flusso_**(Modificare valore con tasto Enter e tasti Su o Giù)
 - Si può impostare Abilitato (ON) o Disabilitato (OFF) per il segnale ingresso.
 - **Calibrazione** (Modifica valore con tasto Enter e tasti Su e Giù)
 - **Full** (pH 7 and 4, Redox 465 mV Soluzioni tampone)
 - **Easy** (pH 7, Redox 465 mV Soluzioni tampone)
 - **Off** (Disabilitato)
 - **Password** (Modifica valore con tasto Enter e tasti Su e Giù, valore standard 0000)
 - **+**
 - **-**
- Salvataggio e uscita dal Menù con tasto ESC
 - **Esci__salva** (Modifica valore con tasto Enter e tasti Su e Giù e conferma con Enter)
-  • Adescamento Pompa tenere premuto tasto Su per 3 secondi e la pompa Redox adesca
 - **priming__700mv**
- Adescamento Pompa tenere premuto tasto Su per 3 secondi e la pompa pH adesca
 - **priming__7.2ph**
- Funzione Blocco Pompa
 - Premere Su e Enter (insieme) dopo 5 secondi si visualizza **Rx_Stop** premere nuovamente per sbloccare
 - Premere Su e Enter (insieme) dopo 5 secondi si visualizza **pH_Stop** premere nuovamente per sbloccare
- Il sistema esegue un dosaggio proporzionale alla misura rispetto al Set point (25% dosaggio minimo, dosaggio massimo 90% di 10 minuti di tempo come periodo di dosaggio)

Note: Il sistema esce dal Menù in automatico dopo 1 minuto di tempo, il sistema non salva nessun parametro.



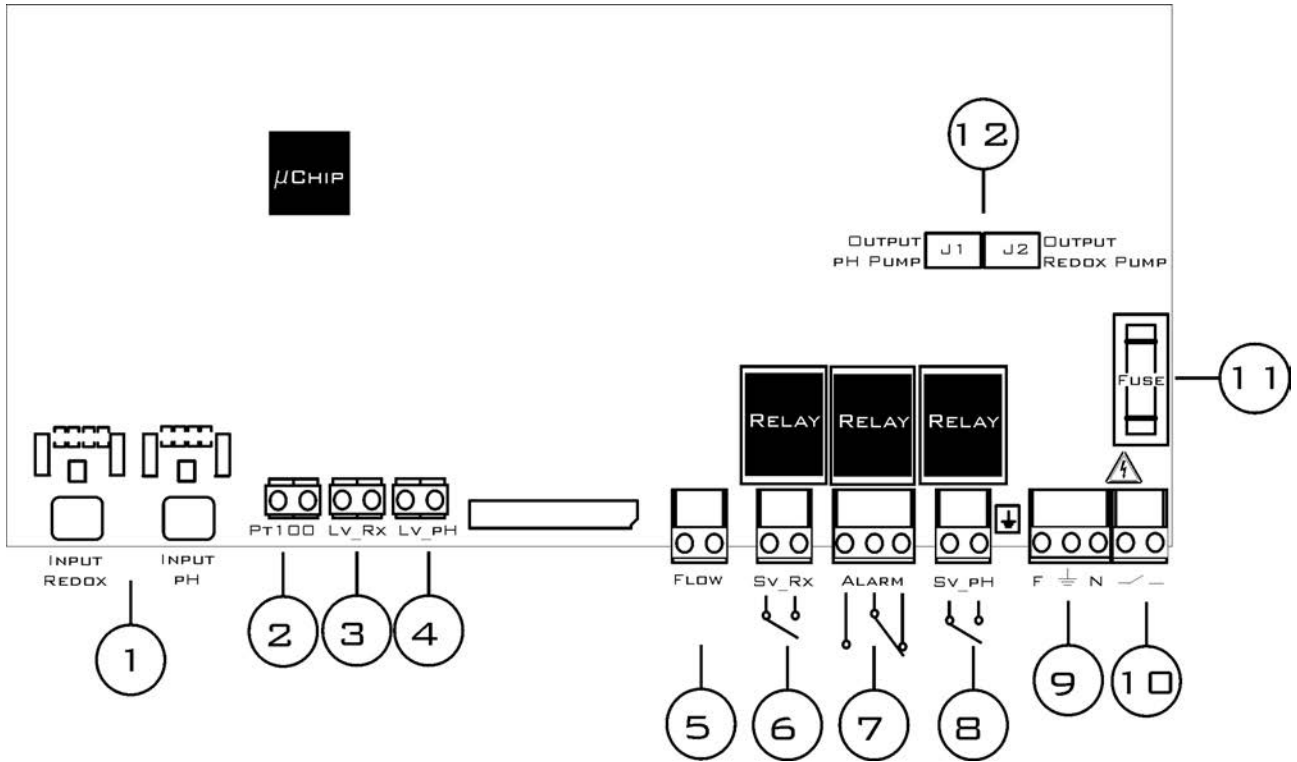





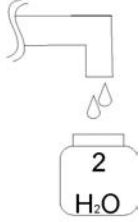
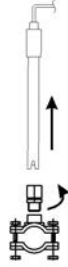

Main board

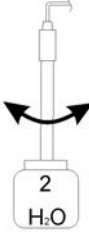

Wire Connection:

- 1) Ingresso sonda pH e Redox
- 2) Ingresso sonda Temperatura (PT100)
- 3) Ingresso sonda Livello Redox (Prodotto nella tanica)
- 4) Ingresso sonda Livello pH (Prodotto nella tanica)
- 5) Ingresso segnale Flusso (Flow Rate) [Segnale elettrico 230 Vac]
- 6) Uscita Relè per Electrovalvola Redox (Contatto pulito, Relè 250 Vac 10 A)
- 7) Uscita Relè per Allarme (Contatto pulito, Relè 250 Vac 10 A)
- 8) Uscita Relè per Electrovalvola pH (Contatto pulito, Relè 250 Vac 10 A)
- 9) Alimentazione sistema 230 Vac 50-60 Hz
- 10) Interruttore di alimentazione
- 11) Fusibile 500 mA ritardato
- 12) Uscita pompa pH (J1) e pompa Redox (J2)

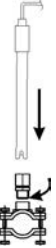





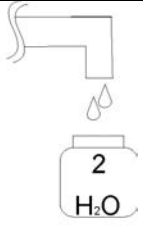

Calibrazione sonda pH

 1	 2	 3 Lavare la sonda
 4 Mantenere la sonda nella soluzione tampone	Calibrazione  Premere il tasto Cal 3 Secondi impostare calibrazione pH. 5	Premere_cal  Durata Calibrazione 1 minuto Attendere__60s_ 6
7pH_Qualita'_100% Qualità sonda 7	 8 Lavare la sonda	 9 Mantenere sonda nella Soluzione tampone
4pH_Premere_cal  Durata Calibrazione 1 minuto Attendere__60s_ 10	4pH_Qualita'_100% Qualità Sonda 11	 12 Lavare la sonda
 13	 Premere Tasto Enter salva esci 14	15 Normale Stato

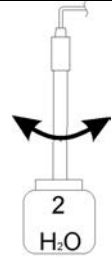
Note:

Se è stato impostato Calibrazione = Easy la funzione sarà per 1 punto, solo soluzione tampone 7 pH.

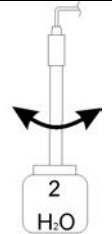
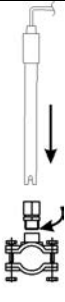
Calibrazione Sonda Redox

<p>①</p> 	<p>②</p> 	<p>③</p>  <p>Lavare la sonda</p>
<p>④</p>  <p>Mantenere la sonda nella soluzione tampone</p>	<p>CalibraZione</p>  <p>Premere il tasto Cal 3 Secondi impostare calibrazione Redox</p> <p>5</p>	<p>465mv_Premere_cal</p>  <p>Durata Calibrazione 1 minuto</p> <p>attendere_60s_</p> <p>6</p>
<p>465mv_Quality_100%</p> <p>Qualità Sonda</p> <p>7</p>	<p>⑧</p> 	<p>⑨</p> 
 <p>Premere Tasto Cal 3 Secondi</p> <p>10</p>	<p>Normale Stato</p> <p>11</p>	

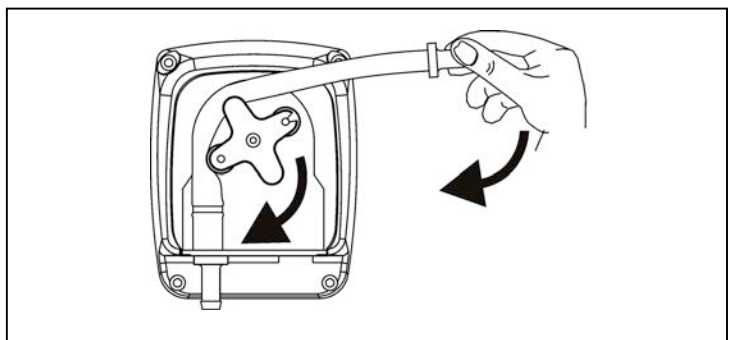
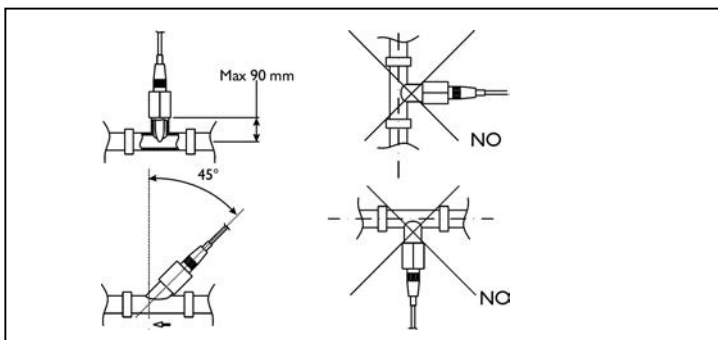
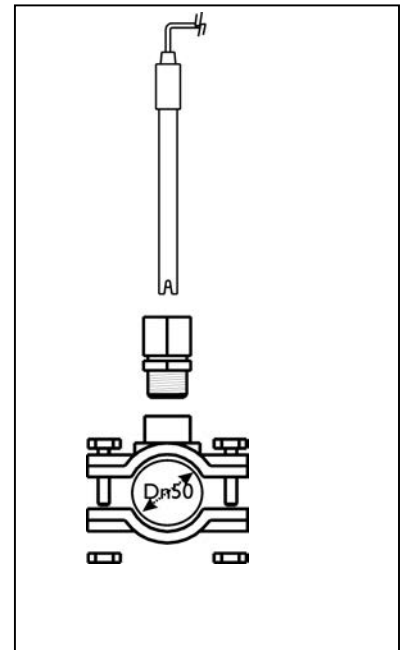
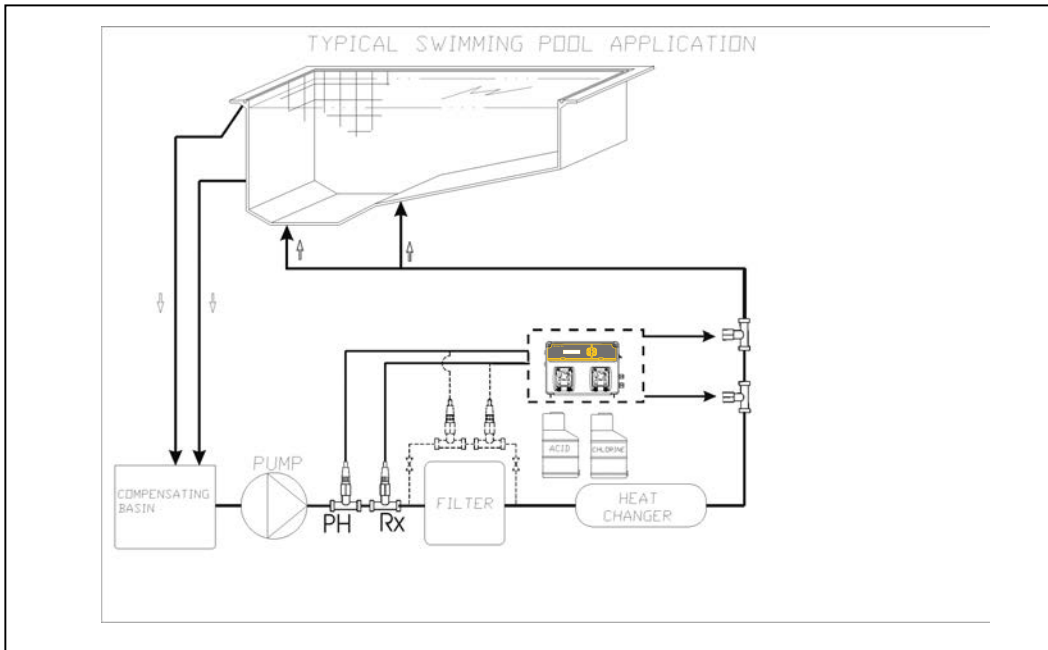

Allarme	Display	Relè	Azione da Fare
Livello	livello__7,2_ph livello__720_mv	Allarme Relè Chiuso	- Premere Enter per aprire Allarme Relè - Ripristinare il Prodotto nella tanica
OFA Primo Allarme (time >70%)	ofa_alr__7,2_ph	Allarme Relè Aperto	- Premere Enter per reset
OFA Secondo Allarme (time =100%)	ofa_stop__7,2_ph	Allarme Relè Chiuso	- Premere Enter per reset
Flusso	Flusso__7,2_ph	Allarme Relè Aperto	- Ripristinare Flusso
System Error	Parameter_error	Allarme Relè Aperto	- Premere Enter per ripristinare parametri Default - Unità rotta
Errore Calibrazione	Errore_7_ph Errore_4_ph Errore_465_mv	Allarme Relè Aperto	- Sostituire sonda o Soluzione tampone ed eseguire la calibrazione

- Parametri di fabbrica:**
- Lingua = UK
 - Set Point valore= 7,4 pH; 750 mV (Rx)
 - Metodo Dosaggio = Acid; Low (Rx)
 - Tempo OFA = OFF
 - Calibrazione = Full
 - Ingresso Flusso= OFF

- Per ripristinare I parametri di fabbrica:**
- Spegnerne il sistema
 - Tenere premuto il tasto SU e Giù insieme accendere il sistema.
 - Il sistema visualizza **IniT.default_no**
 - Premere SU **IniT.default_Yes**
 - Premere Tasto Enter per ripristinare I parametri di fabbrica.

Содержимое упаковки:

- A) pH и REDOX контроллер
- B) ПВХ Cristal 4x6 всасывающая трубка (2 м)
- C) Полиэтиленовая трубка подачи (3 м)
- D) Винтовые анкеры (φ=6 мм)
- E) Нижний фильтр (ПВХ)
- F) ФПМ невозвратный клапан (3/8" GAS)
- G) Зонды pH и Redox
- H) PSS3 держатель зонда (1/2" GAS)
- I) Монтажная скоба для PSS3 для трубы 2 дюйм. (φ=50 мм)
- L) pH 4, pH 7, 465 mV, H₂O буферные растворы
- M) Адаптер для невозвратного клапана

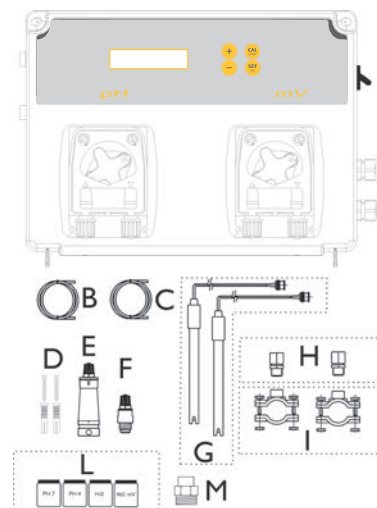

Монтаж на стену

ТЕХНИЧЕСКИЕ ХАРАКТЕРИСТИКИ

Размеры (В – Ш – Д)	234x162x108 мм
Вес	1 кг
Питание:	230 В перем. т. 50-60 Гц
Потребление	12 Вт или 18 Вт
Расход насоса	1,5 л/ч; 5л/ч
Максимальное давление	1,5 бар
Состояние насоса	Пауза - Работа
Шкала измерения	0 ÷ 14.0 pH; Redox 0 ÷ +1000 мВ
Точность	+/- 0,1 pH; ± 10 мВ
Аккуратность	±0.02 pH; ± 3 мВ
Калибровка электрода	Автоматическая

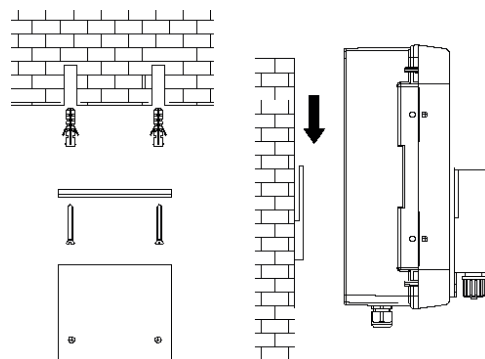

ATTENZIONE / WARNING / ATTENTION / ACHTUNG/ВНИМАНИЕ

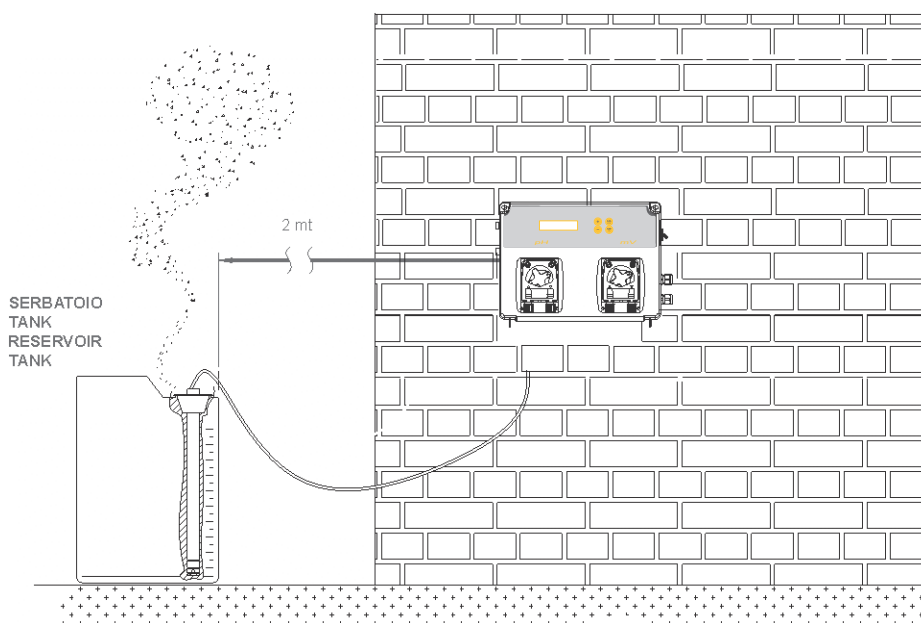

Настройки

Функции:

- Калибровка (нажимать кнопку CAL в течение 3 секунд):
 - Выбрать зонд для калибровки pH или Redox с помощью кнопок Вверх и Вниз.
 - Стандартная функция калибровки зонда с буферными растворами 7 и 4 и 465 мВ для потенциала Redox.
- Уставка (Нажать кнопку Set):
 - Нажать кнопку Set и выбрать измерение с помощью кнопок Вверх и Вниз и нажать Enter для изменения и подтверждения.
 - **Sp_750mv__700_mv_**
 - **Sp_7.4ph__7.6_ph_**
- Нажимать кнопки Cal и Set (одновременно) в течение 5 секунд - выводится настройка программирования:
 - **МЕНЮ**
 - **Язык_** (Можно выбрать язык из 5 возможных: EN, IT, SP, DE, FR)
 - **Измерение_Redox**
 - **setpoint__750_mv** (изменить значение с помощью кнопки Enter и кнопок Вверх и Вниз) Можно задать значение от 0 до 1000 мВ для Redox потенциала.
 - **sp_type__low** (Установить значение LOW или HIGH)
 - **время_ofa__OFF** (Установить значение OFF или необходимое время)
 - **alr_band_100_rx** (Установить значение от 100 до 300 мВ)
 - **Измерение_ph**
 - **setpoint__7.4ph** (изменить значение с помощью кнопки Enter и кнопок Вверх и Вниз) Можно задать значение от 0 до 14 pH
 - **sp_type__acid** (Установить значение ACID или ALKA)
 - **время_ofa__OFF** (Установить значение OFF или необходимое время)
 - **alr_band_1.0_ph** (Установить значение от 1 pH до 3 pH)
 - **Temp_25*C_** (Установить значение с помощью кнопки Enter и кнопок Вверх и Вниз) только pH.
 - **Поток_** (Установить значение с помощью кнопки Enter и кнопок Вверх и Вниз)
 - Можно задать Подключено (ON) или Отключено (OFF) для входного сигнала.
 - **Калибровка_** (Установить значение с помощью кнопки Enter и кнопок Вверх и Вниз)
 - **Full** (pH 7 и 4, Redox 465 мВ буферные растворы)
 - **Easy** (pH 7, Redox 465 мВ буферные растворы)
 - **Off** (Отключено)
 - **Password** (Установить значение с помощью кнопки Enter и кнопок Вверх и Вниз, стандартное значение **0000**)
 - Сохранение и выход из меню с помощью кнопки ESC
 - **Выйти__сохранить** (Установить значение с помощью кнопки Enter и кнопок Вверх и Вниз и подтвердить с помощью Enter)
 - Наполнение насоса - удерживать нажатой кнопку Вверх в течение 3 секунд и насос Redox заполнится
 - **priming__700mv**
 - Наполнение насоса - удерживать нажатой кнопку Вверх в течение 3 секунд и насос pH заполнится
 - **priming__7.2ph**
 - Функция блокировки насоса
 - Нажать кнопки Вверх и Enter (одновременно) через 5 секунд выводится **Rx_Stop** снова нажать для разблокировки
 - Нажать кнопки Вверх и Enter (одновременно) через 5 секунд выводится **pH_Stop** снова нажать для разблокировки
 - Система выполняет дозирование, пропорциональное величине в соответствии с уставкой (25% минимальное дозирование, максимальное дозирование 90% 10 минут - период дозирования)

Примечание: Система автоматически выходит из меню через 1 минуту, система не выполняет сохранения никаких параметров.



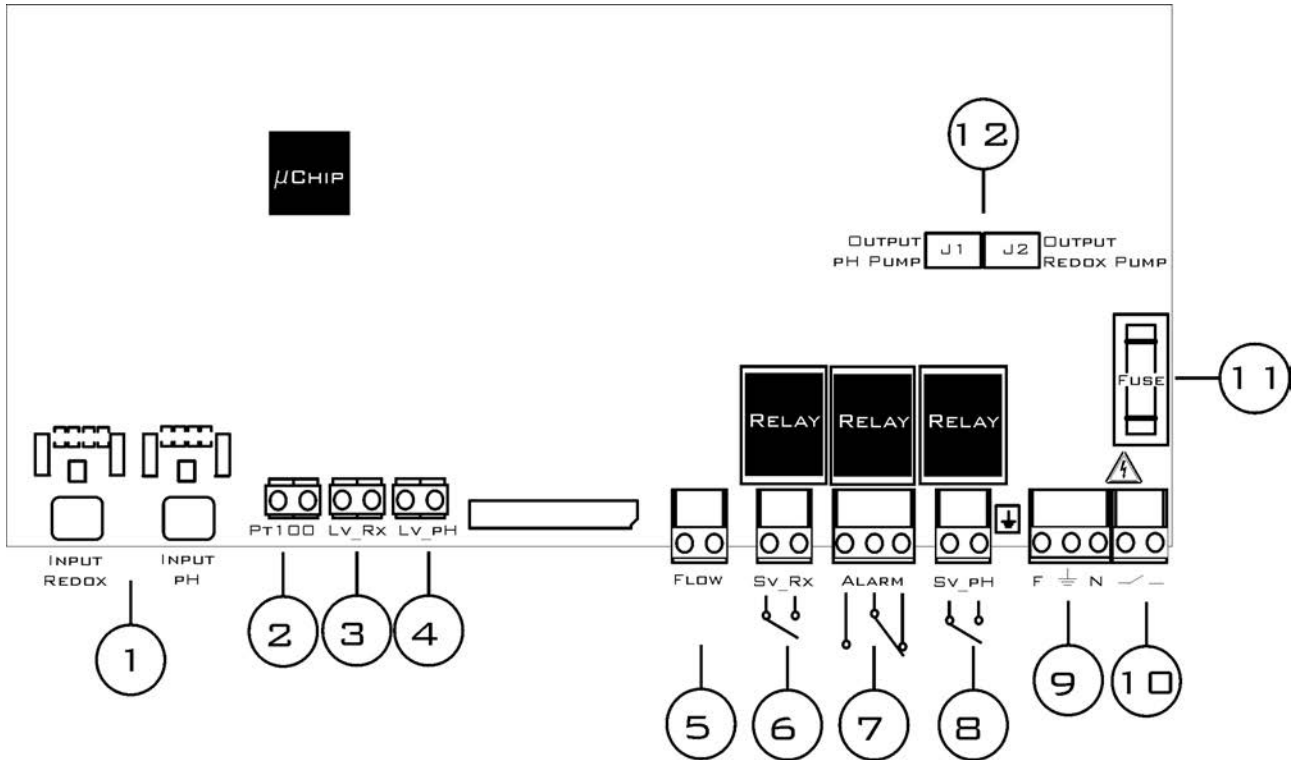





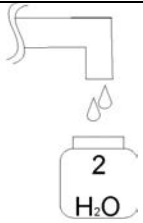

Главная плата



Подключения кабелей:

- 1) Вход зондов pH и Redox
- 2) Вход зонда температуры (PT100)
- 3) Вход зонда уровня Redox (продукта в баке)
- 4) Вход зонда уровня pH (продукта в баке)
- 5) Входной сигнал потока (Flow Rate) [Электрический сигнал 230 В перем.т.]
- 6) Выход реле для электромагнитного клапана Redox (беспотенциальный контакт, реле 250 В перем.т. 10 А)
- 7) Выход реле для аварийного сигнала (беспотенциальный контакт, реле 250 В перем.т. 10 А)
- 8) Выход реле для электромагнитного клапана pH (беспотенциальный контакт, реле 250 В перем.т. 10 А)
- 9) Питание системы 230 В перем.т. 50-60 Гц
- 10) Выключатель питания
- 11) Плавкий предохранитель 500 мА замедленного действия
- 12) Выход насоса pH (J1) и насоса Redox (J2)

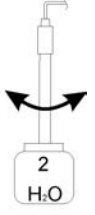





Калибровка зонда pH

<p>①</p> 	<p>②</p> 	<p>③</p>  <p>Вымыть зонд</p>
<p>④</p>  <p>Поместить зонд в буферный раствор</p>	<p style="text-align: center;">Калибровка</p>  <p>Нажимать на кнопку Cal в течение 3 секунд задать калибровку pH.</p> <p>5</p>	<p style="text-align: center;">Нажать_cal</p>  <p>Продолжительность калибровки - 1 минута</p> <p style="text-align: center;">Обождать__60с_</p> <p>6</p>
<p>7pH_Качество_100%</p> <p>Качество зонда</p> <p>7</p>	<p>⑧</p>  <p>Вымыть зонд</p>	<p>⑨</p>  <p>Поместить зонд в буферный раствор</p>
<p>4pH_Нажать_cal</p>  <p>Продолжительность калибровки - 1 минута</p> <p style="text-align: center;">Обождать__60с_</p> <p>10</p>	<p>4pH_Качество_100%</p> <p>Качество зонда</p> <p>11</p>	<p>⑫</p>  <p>Вымыть зонд</p>
<p>⑬</p> 	 <p>Нажать кнопку Enter сохранить и выйти</p> <p>14</p>	<p>15</p> <p>Нормальное состояние</p>

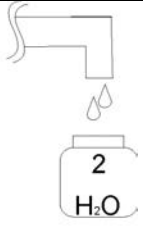
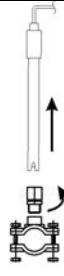
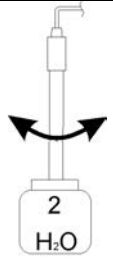
Примечание:

Если задано Калибровка= Easy, функция выполняется для 1 точки, только буферный раствор 7 pH.

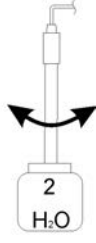
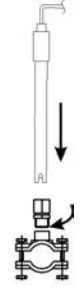
Калибровка зонда Redox

<p>1</p> 	<p>2</p> 	<p>3</p>  <p>Вымыть зонд</p>
<p>4</p>  <p>Поместить зонд в буферный раствор</p>	<p>5</p> <p style="text-align: center;">Калибровка</p>  <p>Нажимать на кнопку Cal в течение 3 секунд задать калибровку Redox</p>	<p>6</p> <p style="text-align: center;">465mV_Нажать_cal</p>  <p>Продолжительность калибровки - 1 минута обождать_60с_</p>
<p>7</p> <p>465mV_Качество_100%</p> <p>Качество зонда</p>	<p>8</p> 	<p>9</p> 
<p>10</p>  <p>Нажимать кнопку Cal в течение 3 секунд</p>	<p>11</p> <p>Нормальное состояние</p>	

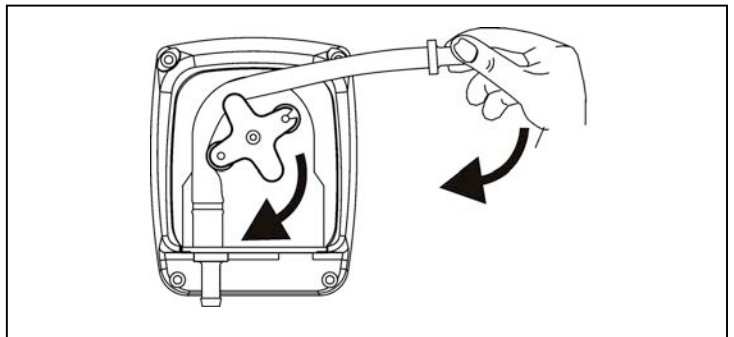
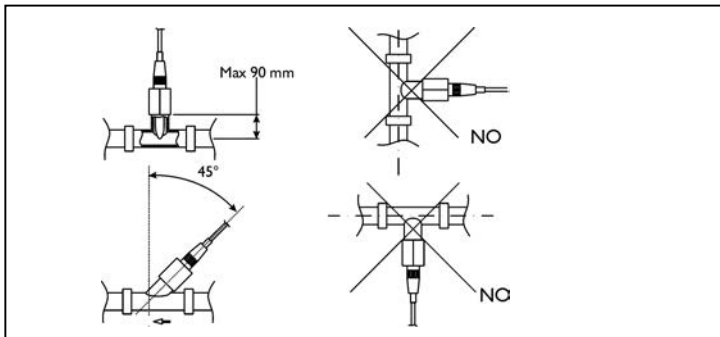
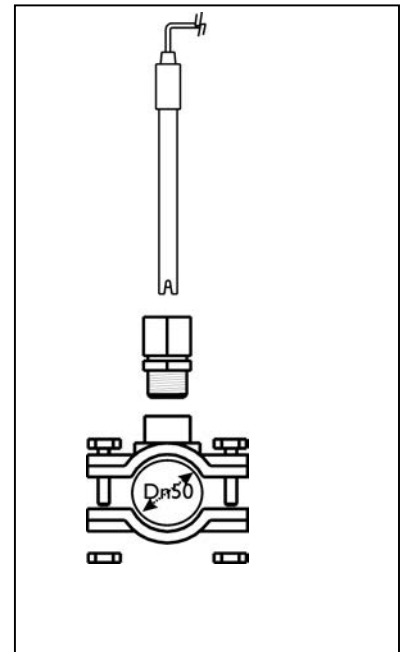
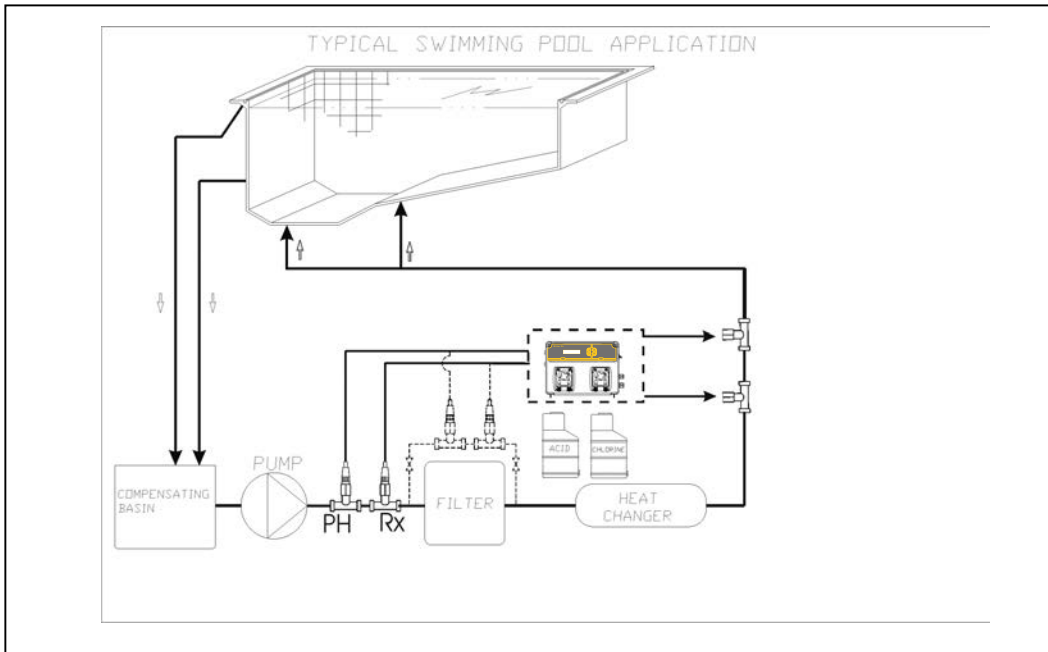

Аварийный сигнал	Дисплей	Реле	Необходимые действия
Уровень	уровень__7,2_ph уровень__720_mv	Аварийное реле закрыто	- Нажать Enter для открытия реле аварийного сигнала - Добавить продукт в бак
OFA Первый аварийный сигнал (time >70%)	ofa_alr_7,2_ph	Аварийное реле открыто	- Нажать Enter для сброса
OFA Второй аварийный сигнал (time >100%)	ofa_stop__7,2_ph	Аварийное реле закрыто	- Нажать Enter для сброса
Поток	Поток__7,2_ph	Аварийное реле открыто	- Восстановить поток
Ошибка системы	Parameter_Error	Аварийное реле открыто	- Нажать Enter для восстановления параметров по умолчанию (Default) - Блок неисправен
Ошибка калибровки	Errore_7_ph Errore_4_ph Errore_465_mv	Аварийное реле открыто	- Заменить зонд или буферный раствор и выполнить калибровку

- Заводские параметры:**
- Язык = **UK**
 - Значение установки = **7,4 pH; 750 mV (Rx)**
 - Метод дозирования = **Acid; Low (Rx)**
 - Время OFA = **OFF**
 - Калибровка = **Full**
 - Вход потока = **OFF**

- Для восстановления заводских параметров:**
- Выключить систему
 - Одновременно удерживая кнопки ВВЕРХ и ВНИЗ, включить систему.
 - Система выведет **IniT.default_no**
 - Нажать ВВЕРХ **IniT.default_Yes**
 - Нажать Enter для восстановления заводских параметров